

НеваРеактив

# Lab and Field Instrumentation

pH · ORP · ISE · DISSOLVED OXYGEN · CONDUCTIVITY ·  
MULTI-PARAMETER · BOD/RESPIRATION · PHOTOMETRY · TURBIDITY

НеваРеактив



a xylem brand

## Contents

	Page
Publisher	1
New products	2-5
Descriptions of benchtop and portable meters	6-21
Multi-parameter measurement	22-51
pH measurement	52-69
Meters	52-62
Electrodes/accessories	63-69
ORP	70-73
Ion-selective	74-83
Meters	74-80
Electrodes/accessories	81-83
Oxygen	84-93
Meters	84-91
Sensors/accessories	92-93
Conductivity	94-111
Meters	94-104
Cells/accessories	105-111
BOD/Respiration	112-129
Photometry	130-163
Spectrophotometers photoLab® 7000 Series	134-140
Filter photometers photoLab® Series	141-142
Portable photometers photoFlex® Series	143-147
Thermoreactors	148-149
Test kits/reagents and accessories	150-163
Turbidity	164-171
Software, documentation	172-175
General information	176-184
Services, certificates	176-179
About us	180-182
Index	183-184

Publisher



**Xylem Analytics Germany Sales  
GmbH & Co. KG, WTW®**

Dr.-Karl-Slevogt-Straße 1  
D-82362 Weilheim

Germany

Tel: +49 881 183-0

Fax: +49 881 183-420

Email: [Info.WTW@Xyleminc.com](mailto:Info.WTW@Xyleminc.com)

Internet: [www.WTW.com](http://www.WTW.com)



# IDS goes wireless - the new portable and laboratory meters with wireless data transfer

Wireless measurement - Perfect for anywhere where cables or meters can be inconvenient, such as when using fume hoods or laminar flow benches, in confined space conditions, or simply in any place where you want to have an additional hand free.

- **Wireless measurement**
- **Securely connected**
- **A wireless module for all parameters**



## New: Specific applications need specific sensors

There are new SenTix® IDS electrodes for measuring pH of solid and semi-solid samples, small sample volumes, emulsions and suspensions, as well as highly precise low-maintenance types.

New conductivity cells based on tried and tested TetraCon® technology: The TetraCon® 925/C with acid-resistant sensor head from PEEK for special applications, such as in galvanic baths. The TetraCon® 925/LV with forked electrode holder is suitable for small volumes or viscous media.

All IDS sensors are available as a plug head version for wireless transmission!

see from page 28



НеваРеактив



### inoLab® Multi IDS benchtop meters: The perfect partners in the IDS wireless system

The new inoLab® Multi IDS meters and IDS sensors – the perfect combination for efficient and precise work in the laboratory. Regardless of whether connected by cable or equipped with the new wireless modules for IDS plug head sensors, reliable measurements with comprehensive documentation are guaranteed with all meter and sensor data.

And the new MultiLab® user software enables GLP/GMP-compliant user management with different authorization levels. Modern communication interfaces ensure smooth data transfer.

*see from page 40*



### Portable, robust, digital – the new MultiLine® IDS Series

MultiLine® IDS guarantees robust, waterproof and reliable portable meters for mobile measurement.

With three different designs, there is one for every customer's need, from reliable entry-level to professional three-channel meters. The new wireless technology is available on each of these meters as well!

*see from page 43*

НеваРеактив

# photoLab® 7600 UV-VIS with innovative reagent-free measurement

OptRF - the optical reagent-free measurement

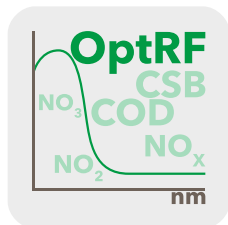

- **Fast and direct**
- **Reagent-free and environmentally friendly**
- **Does not pose a health hazard**

With spectral scanning in the UV range, WTW has brought optical reagent-free measurement from process instruments into the laboratory. COD, nitrate and nitrite from communal waste water can be recorded, calculated, and immediately displayed as a measurement value using a spectral scan in a quartz cell.

see page 139

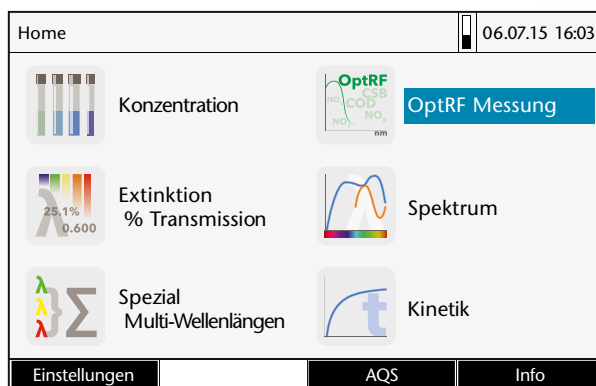

## photoLab color - color measurement instead of color perception



- **PC-controlled**
- **Conforming to standard**
- **CSV and PDF export**

photoLab® color offers PC-controlled color measurement with the spectral photometers from the photoLab® 6000 and 7000 Series for the quality control of substances from water to wine, and from resin to sugar.

photoLab® Data spectral comes in a package with photoLab® color and facilitates the SI P-compliant data management of all other photometric measurement data.

see page 137

НеваРеактив

# photoLab® 7600 UV-VIS - the "universal genius" for routine and spectra analysis

- **OptRF: Reagent-free COD, nitrate, nitrite**
- **Routine and special analysis**
- **Barcode and AQA support**

The new spectral photometers in the photoLab® 7000 Series offer proven routine analysis functions with approx. 250 standard methods. Alongside the innovative OptRF measurement, special methods from glucose to chlorophyll, and user programming for research, industry, and service laboratories are available.

see page 139



# Descriptions

## Benchttop and portable meters



### Content

- 7 *IDS - Intelligent digital sensors*
- 7 *IDS goes wireless*
- 8 *Benchttop meters inoLab® Multi IDS - digital*
- 11 *Portable meters MultiLine® IDS - digital*
- 14 *Benchttop meters inoLab® - analogue*
- 18 *Portable meters ProfiLine - analogue*

# IDS - Intelligent digital sensors

IDS focuses on the sensors. The unique WTW IDS sensors offer three main advantages:

- Reliable measurement results through clear assignment of the measured value to the sensor. Each IDS sensor transmits its description, serial number, and current calibration status
- Correct measurement results due to direct signal processing in the sensor and digital transmission of the values. Cable lengths up to 100 m for all parameters are easily possible
- High-quality, long-term proven sensors as a basis for IDS technology

Unique quality functions such as the intelligent sensor evaluation (QSC) at pH support operational safety by information about the actual state of the electrode.

IDS sensors are available for pH, ORP, dissolved oxygen, conductivity and turbidity.

## IDS goes wireless



We have set another milestone in the measurement of pH/ORP, dissolved oxygen, conductivity and turbidity with the wireless transmission of measured parameters!

With the plug head IDS sensors and universal rechargeable wireless modules, all measurement problems in hard-to-reach locations such as fume hoods, safety workbenches, or any other place cables are convenient, can be mastered in no time at all. With a range of up to 10 meters, you can keep the instrument in a safe place and have a hand free.

Universal wireless modules for meters and sensors make working very easy.

- Each meter requires only one IDS WLM-M module
- One meter measures up to three sensor modules simultaneously, depending on the model
- A sensor module IDS WLM-S can be used with any IDS plug head sensor

Suitable for all new MultiLine® Multi 3630 IDS, Multi 3620 IDS, Multi 3510 IDS and inoLab® Multi 9630 IDS inoLab® Multi 9620 IDS and inoLab® Multi 9310 IDS.

НеварРеактив



Descriptions benchtop and portable meters

НеварРеактив



# Digital benchtop meters inoLab® IDS **inoLab**

Trusted measurements with the most modern multi-channel meters **inoLab® Multi 9630 IDS, inoLab® Multi 9620 IDS, inoLab® Multi 9310 IDS** All meters have the following:

- ✓ yes
- yes
- ✓ recommended
- ✓ recommended for some applications
- not recommended/not available

		Digital			
		inoLab® IDS			
		Multi 9630	Multi 9620	Multi 9310	
2 parameters simultaneously		✓	✓		
3 parameters simultaneously		✓			
pH	IDS-pH electrodes: SenTix® 9xx, SensoLyt® 900	28	●	●	●
	All SenTix® electrodes with DIN or BNC plug	65	●*	●*	
ORP	IDS ORP electrodes: SenTix® ORP 900-T, SensoLyt® ORP 900	32	●	●	●
	All SenTix® electrodes with DIN or BNC plug	73	●*	●*	●**
ISE (pH/ION function)	ISE electrodes	81	●*	●*	
	Ion-specific measurement programs	40	●	●	
Dissolved oxygen	IDS Optical dissolved oxygen sensor: FDO® 925	33	●	●	●
Conductivity	IDS Conductivity cells: TetraCon® 925, LR 925/01	34	●	●	●
Turbidity	IDS turbidity sensor VisoTurb® 900	36	●	●	●
Routine measurements		✓	✓	✓	
Routine measurement with documentation		✓	✓	✓	
AQA with documentation		✓	✓	✓	
R&D High resolution and precision		✓	✓	✓	
Control measurements		✓	✓	✓	
LIMS connection		✓	✓	✓	
Quality assurance		✓	✓	✓	
Education		✓	✓	✓	
Service		–	–	–	
Laboratory measurements		✓	✓	✓	
Field measurements		–	–	–	
Depth measurements		–	–	–	
Measurement according to pharmacopoeia:	Conductivity	✓***	✓***	✓***	
	diss. Oxygen	✓	✓	✓	
PC connection		✓	✓	✓	
Memory		✓	✓	✓	
USB interface		✓	✓	✓	
Printer option				✓	
Graphic display				✓	
Color graphic display		✓	✓		

\* analogue electrodes can also be connected via an insertable DIN-/BNC adapter  
 \*\* analogue electrodes with S7 plug head connectable via ADA S7/IDS  
 \*\*\* via comparison measurement

Multi 9630	Multi 9620	Multi 9310
------------	------------	------------

see page 40 40 41

Неварреактив

# inoLab® Multi 9630 IDS/Multi 9620 IDS

The inoLab® Multi 9630 IDS and 9620 IDS are the top in their class. They are wireless ready and measure three (9630) or two (9620) of the following parameters simultaneously: pH, ORP, ISE, dissolved oxygen, conductivity or turbidity.

Complete GMP/GLP compliant documentation is possible.

## Housing

High-quality housing with die-cast zinc lower case, large color display and antibacterial keyboard.

## Display

Large color graphic display in 16: 9 format, with CMC, QSC and measurement channel display, as well as soft keys for additional functions. Depending on the number of channels present, two or three main parameters are shown simultaneously. Individual presentation is also possible. Hygienic, easy-to-clean glass pane.

## Connectors

High-quality, tightly sealed socket field with moulded connectors for IDS sensors. There are three connections on the inoLab® Multi 9630, and two connections on the inoLab® Multi 9620

## Keyboard

Easy-to-clean, antibacterial membrane keypad with clear pressure points for convenient operation and hygienic work.

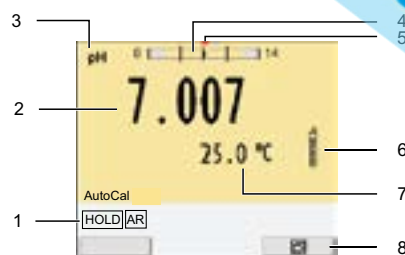

- 1 Status information
- 2 Measurement value (with unit)
- 3 Measured parameter
- 4 Continuous measurement value control (CMC function; with pH measurement)
- 5 Display of the active sensor connection (measurement channel display)
- 6 Sensor symbol (calibration evaluation)
- 7 Temperature measurement value (with unit)
- 8 Soft keys and date/time

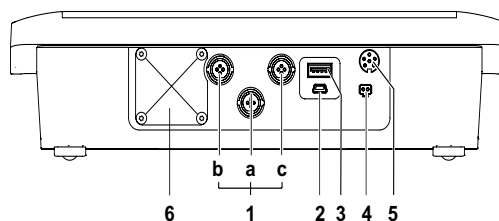

- 1 Three or two universal IDS sensor connectors (measurement channels) also for IDS wireless module
- 2 Mini USB-B for the connection to a PC (data transfer, firmware update, set up of a user management, power supply via USB)
- 3 USB-A socket for the connection of USB memory stick or selected printers
- 4 Connection for power supply through AC adapter
- 5 Service interface
- 6 Plug location for analogue pH/mV/ISE module

Order information see page 42



Неварреактив

# inoLab® Multi 9310 IDS

The compact all-rounder of the IDS family: With one measuring channel and wireless ready pH, ORP, dissolved oxygen, conductivity and turbidity can be measured.

Comes with all the advantages of IDS technology, such as complete GLP documentation of all meter and sensor data.

## Housing

Smooth plastic housing with rounded edges and stand base for bolting on. A version with a built-in thermal printer (58 mm) is available.

## Display

Bright and high-contrast black and white graphic display with soft keys and clear presentation.

## Connectors

High-quality socket field with tightly sealed connection for IDS sensors (one connection).

## Keyboard

Smooth and easy-to-clean membrane keypad in a user-friendly layout with clear pressure points.

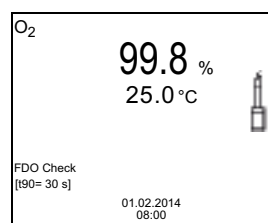
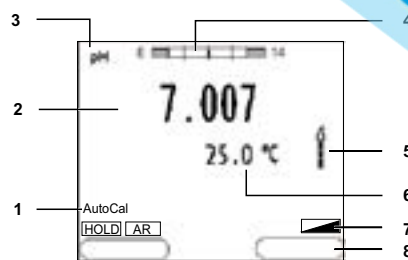

- 1 Status information
- 2 Measurement value (with unit)
- 3 Measured parameter
- 4 Continuous measurement value control (CMC function; with pH measurement)
- 5 Sensor symbol (calibration evaluation)
- 6 Temperature measurement value (with unit)
- 7 Status information (meter)
- 8 Soft keys and date/time

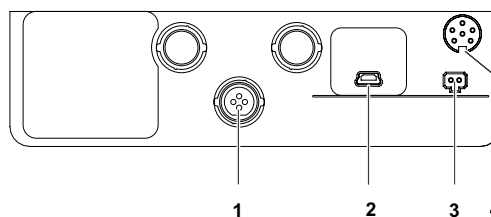

- 1 Universal IDS sensor connections (measurement channels), also for IDS wireless module
- 2 Mini USB-B for the connection to a PC (data transfer, firmware update, set up of a user management, power supply via USB)
- 3 Connection for power supply through AC adapter
- 4 Service interface

Order information see page 42

Неварреактив

НеварРеактив

# Digital portable meters MultiLine® IDS MultiLine®

The digital portable meters for IDS sensors: **Multi 3630 IDS, Multi 3620 IDS, Multi 3510 IDS**: State-of-the-art portable measurement pH/mV, dissolved oxygen, conductivity and turbidity as well as depth profile measurement (Multi 3630 IDS). Robust, field-suitable and prepared for wireless measurement. Also available in a sets with various sensors.

- ✓ yes
- yes
- ✓ recommended
- ✓ recommended for some applications

		Digital			
		MultiLine® IDS			
		Multi 3630	Multi 3620	Multi 3510	
2 parameters simultaneously		✓	✓		
3 parameters simultaneously		✓			
pH	IDS-pH electrodes: SenTix® 9xx, SensoLyt® 900	28	●	●	●
	All SenTix® electrodes with S7 plug head	65	●**	●**	●**
ORP	IDS ORP electrodes: SenTix® ORP 900-T, SensoLyt® ORP 900	32	●	●	●
	All SenTix® electrodes with S7 plug head	73	●**	●**	●**
Dissolved oxygen	IDS dissolved oxygen sensor: FDO® 925	33	●	●	●
Conductivity	IDS measuring cells: TetraCon® 925, LR 925/01	34	●	●	●
Turbidity	IDS turbidity sensor: VisoTurb® 900-P	36	●	●	●
Multi-parameter	IDS Depth sonde MPP 930	38	●		
Routine measurements		✓	✓	✓	
Routine measurements with documentation		✓	✓	✓	
AQA with documentation		✓	✓	✓	
R&D: High resolution and precision		✓	✓	✓	
Control measurements		✓	✓	✓	
LIMS connection		✓	✓	✓	
Quality assurance		✓	✓	✓	
Education		✓	✓	✓	
Service		✓	✓	✓	
Laboratory measurements		✓	✓	✓	
Field measurements		✓	✓	✓	
Depth measurements		✓	✓	✓	
PC connection		✓	✓	✓	
Memory		✓	✓	✓	
USB interface		✓	✓	✓	
Graphic display				✓	
Color graphic display		✓	✓		

\* analogue electrodes can also be connected via an insertable DIN-/BNC adapter  
 \*\* analogue electrodes with S7 plug head connectable via ADA S7/IDS

see page 44 45 46

Descriptions benchtop and portable meters

НеварРеактив

# Multi 3630 IDS/Multi 3620 IDS

Highest measurement safety and comfort in the field: The Multi 3630 IDS and 3620 IDS wireless ready portable meters are waterproof, robust and leave nothing to be desired in terms of parameter selection, operating comfort and data transmission options.

## Housing

Water- and dust-tight housing according to IP 67 for use outdoors and in a facility The armor SM Pro (component of the sets, as well as in the individual scope of delivery) offers additional protection.

## Display

Brilliant color graphic display with clear plastic pane, with CMC, QSC and channel display, as well as soft keys for additional functions. Depending on the number of channels present, two or three main parameters can be shown simultaneously, or a single channel may be displayed alone if prefer.

## Connectors

Inwardly waterproof sealed socket field with three or two universal sensor connectors, when plugged in IP 67 (also for IDS wireless module).

## Keyboard

Silicon keyboard that can also be operated with gloves made of one piece with embossed keys and tactile and acoustic feedback. waterproof and easy to clean.

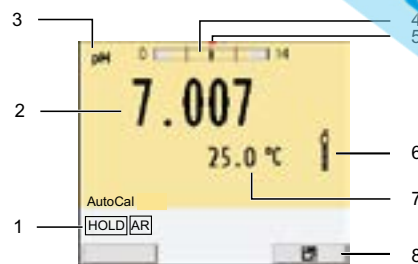

- 1 Status information
- 2 Measurement value (with unit)
- 3 Measured parameter
- 4 Continuous measurement value control (CMC function; with pH measurement)
- 5 Display of the active sensor connection (measurement channel display)
- 6 Sensor symbol (calibration evaluation)
- 7 Temperature measurement value (with unit)
- 8 Soft keys and date/time

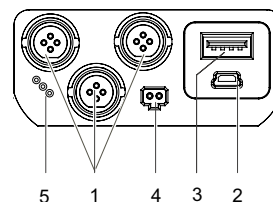

- 1 Three or two universal IDS sensor connections (measurement channels) also for IDS wireless module
- 2 Mini USB-B for the connection to a PC (data transfer, firmware update, set up of a user management, power supply via USB)
- 3 USB-A socket for the connection of USB memory stick or selected printers
- 4 Connection for power supply through AC adapter
- 5 Service interface



Order information see page 46

# Multi 3510 IDS

Simply Multi: With one measuring channel and wireless ready, pH, ORP, dissolved oxygen, conductivity and turbidity can be measured sequently. Robust and reliable in the field with IDS technology for complete documentation of all meter and sensor data.

## Housing

Water- and dust-proof housing according to IP 67 for use outdoors and in a facility.

## Display

Backlit black/white graphic display, also for use in challenging lighting conditions. Supports QSC and CMC display, contains soft keys for additional functions.

## Connectors

Waterproof sealed socket field with a sensor connection, when plugged in IP 67 (also for IDS wireless module).

## Keyboard

Silicon keyboard that can be operated with gloves and has tactile and acoustic feedback. One piece molded design is waterproof and easy to clean.

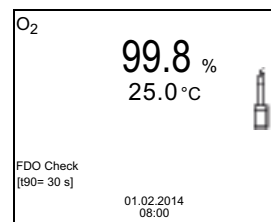
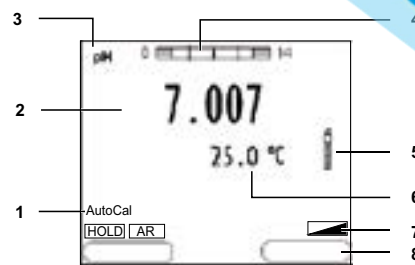

- 1 Status information
- 2 Measurement value (with unit)
- 3 Measured parameter
- 4 Continuous measurement value control (CMC function; with pH measurement)
- 5 Sensor symbol (calibration evaluation)
- 6 Temperature measurement value (with unit)
- 7 Battery display
- 8 Soft keys and date/time

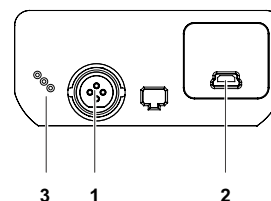

- 1 Universal IDS sensor connections (measurement channels), also for IDS wireless module
- 2 Mini USB-B for the connection to a PC (data transfer, firmware update, set up of a user management, power supply via USB)
- 3 Service interface

Order information see page 46

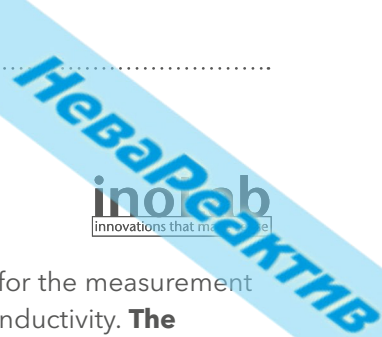

# Analogue benchtop meters inoLab®



The inoLab® family has long been a well-known term for first-class benchtop meters for the measurement of standard parameters such as pH/mV, ion concentrations, dissolved oxygen and conductivity. **The inoLab® 7320, inoLab® 7310 and inoLab® 7110 lines leave nothing to be desired during measurement.** All meters of the 7310 and 7110 lines are also available in sets with sensors.

- ✓ yes
- yes
- ✓ recommended
- ✓ recommended for some applications
- not recommended/not present

	analogue					
	inoLab®					
	pH 7110	Cond 7110	pH 7310	Oxi 7310	Cond 7310	pH/ION 7320
2 parameters simultaneously						✓
pH	●		●			●
ORP	●		●			●
ISE						●
Dissolved oxygen				●		
Conductivity		●			●	
Routine measurements	✓	✓	✓	✓	✓	✓
Routine measurements with documentation			✓	✓	✓	✓
AQA with documentation			✓	✓	✓	✓
R&D - high resolution and precision			✓	✓	✓	✓
Control measurements	✓	✓	✓	✓	✓	✓
LIMS connection			✓	✓	✓	✓
Quality assurance			✓	✓	✓	✓
Education	✓	✓	✓	✓	✓	✓
Service	–	–	–	–	–	–
Laboratory measurements	✓	✓	✓	✓	✓	✓
Field measurements						
PC connection			✓	✓	✓	✓
Memory			✓	✓	✓	✓
USB interface			✓	✓	✓	✓
Graphic display			✓	✓	✓	✓
	Compatible sensor systems					
	Analogue electrodes					
pH electrodes	65	✓	✓			✓
ORP electrodes	73	✓	✓			✓
ISE electrodes	81					✓
Dissolved oxygen sensors	92			✓		
Conductivity cells	105		✓		✓	

see page 57 99 57 88 98 42



# inoLab® 7310

Reliable, conveniently operated benchtops with documentation functions for GLP measurement in the laboratory with analogue sensors for pH/ORP, dissolved oxygen and conductivity. Also available with a built in printer.

## Housing

Smooth plastic housing with rounded edges and attachable stand. Available with built-in thermal printer (58 mm).

## Display

Backlit graphic display with clearly structured menus for comfortable and safe operation.

## Connectors

High-quality socket field with a connector for analogue pH/ORP or oxygen or conductivity sensors.

## Keyboard

Smooth and easy to clean membrane keypad with convenient pressure points and acoustic feedback. Clear layout to support optimal operation.

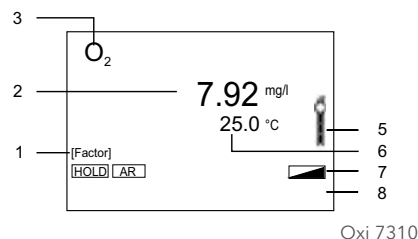
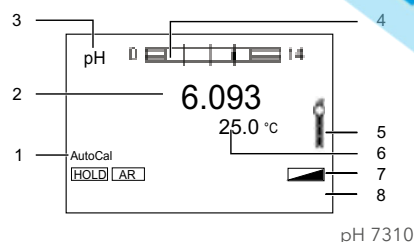

- 1 Status information
- 2 Measurement value (with unit)
- 3 Measured parameter
- 4 Continuous measurement value control (CMC function; with pH 7310)
- 5 Sensor symbol (calibration evaluation)
- 6 Temperature measurement value (with unit)
- 7 Status information (meter)
- 8 Soft keys and date/time

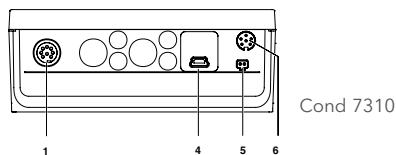
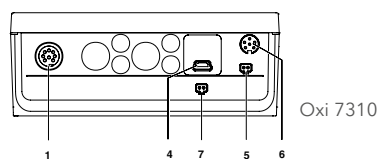
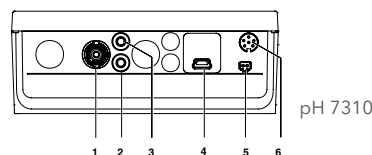

- 1 Connection for pH electrode or conductivity or dissolved oxygen sensor
- 2 Reference electrode (with pH 7310)
- 3 Temperature sensor (with pH 7310)
- 4 Mini USB-B interface for data transfer and firmware update
- 5 Connection for power supply
- 6 Service interface
- 7 Power supply for StirrOx dissolved oxygen sensor (with Oxi 7310)

Order information see page  
57 (pH), 88 (Oxi), 99 (Cond)



# inoLab® pH/ION 7320

Precise 2-channel benchtop meter for pH/ISE/ORP measurement with analogue sensors and GLP-supporting documentation functions. With preprogrammed ISE incremental functions and on request with built-in printer.

## Housing

Smooth plastic housing with rounded edges and stand to be fixed at the meter. If required with installed thermal printer (58 mm).

## Display

Backlit graphic display for simultaneous display of the two measuring inputs. Clearly structured menus for convenient and safe operation.

## Connectors

DIN or BNC sockets for pH/mV sensors, with additional inputs for reference electrodes and temperature sensor; 8 pin inputs for conductivity and oxygen electrodes.

Mini USB-B interface for data transfer and firmware update, socket for power supply.

## Keyboard

Smooth and easy to clean membrane keypad with pleasant pressure points and acoustic feedback.

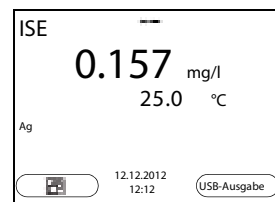
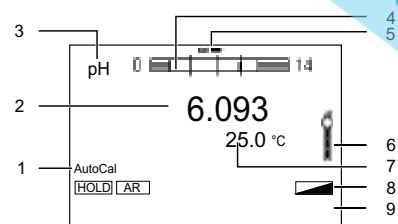

- 1 Status information
- 2 Measurement value (with unit)
- 3 Measured parameter
- 4 Continuous measurement value control (CMC function; with pH measurement)
- 5 Channel display Plug position of the sensor
- 6 Sensor symbol (calibration evaluation)
- 7 Temperature measurement value (with unit)
- 8 Status information (meter)
- 9 Soft keys and date/time

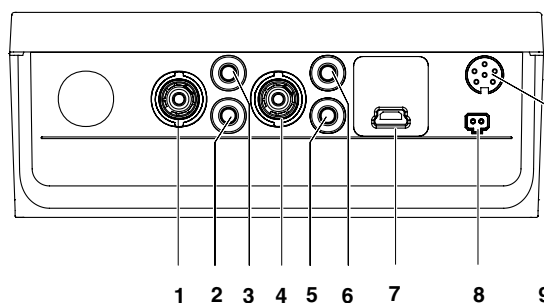

- 1 Connection for pH electrode or ISE electrode (channel 1)
- 2 Reference electrode (with pH /ISE measurement)
- 3 Temperature probe (with pH /ISE measurement)
- 4 Connection for pH electrode or ISE electrode (channel 2)
- 5 Reference electrode (with pH /ISE measurement)
- 6 Temperature probe (with pH /ISE measurement)
- 7 Mini USB-B interface for data transfer and firmware update
- 8 Connection for power supply through AC adapter
- 9 Service interface

Order information see page 78

# inoLab® 7110

Easy-to-use benchtop meters for the routine measurement of pH/ORP or conductivity. With a smooth, easy-to-clean surface and large, clear display.

## Housing

Compact plastic housing with rounded edges and smooth surface. With separate attachable electrode stand.

## Display

Large, clear and easy-to-read LCD segment display.

## Connectors

Quality is also the top priority for these meters. High-quality socket field made of one cast, DIN or BNC sockets for pH/mV sensors, with additional inputs for reference electrodes and temperature sensors; 8 pin inputs for conductivity electrodes, socket for plug power supply.

## Keyboard

Smooth, easy to clean membrane keypad with convenient pressure points and acoustic feedback. Reduced numbers of keys for easy and safe operation.

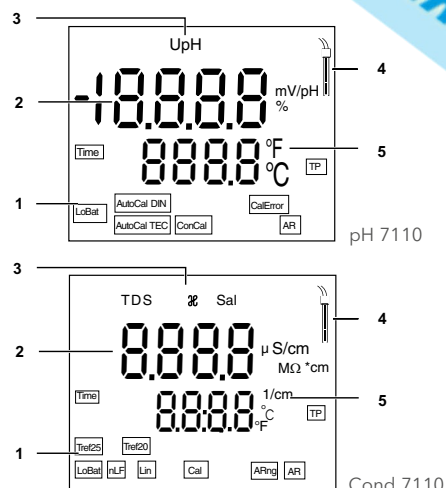

- 1 Status information
- 2 Measurement value (with unit)
- 3 Measured parameter
- 4 Sensor symbol (calibration evaluation))
- 5 Temperature measurement value (with unit)

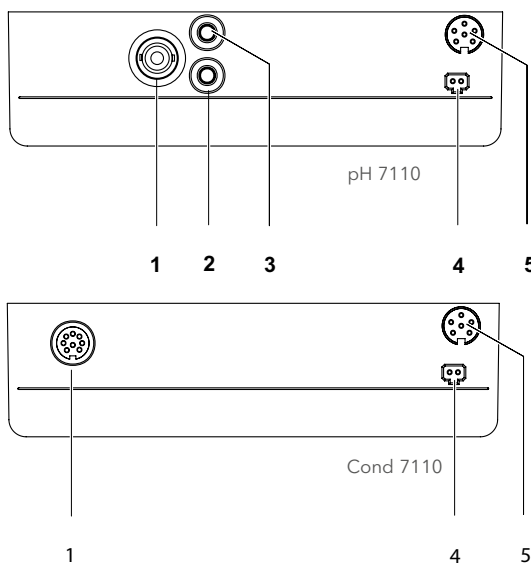

- 1 Connection for pH electrode or conductivity cell
- 2 Reference electrode (with pH measurement)
- 3 Temperature probe (with pH measurement)
- 4 Connector for power supply through AC adapter
- 5 Service interface

Descriptions benchtop and portable meters

Order information see page 57 (pH), 99 (Cond)

# Analogue portable meters ProfiLine

The proven ProfiLine family of analogue portable meters for the mobile measurement of pH/mV, dissolved oxygen and conductivity. Robust, field-suitable multi and ISE single parameter meters. On request available in sets with proven sensors.

- ✓ yes
- yes
- ✓ recommended
- ✓ recommended for some applications

		analogue								
		ProfiLine								
		pH 3110	Oxi 3205	Cond 3110	pH 3310	Oxi 3310	Cond 3310	pH/ION 3310	Multi 3320	pH/Cond 3320
2 parameters simultaneously									✓	✓
pH/ORP		●			●			●	●	●
ISE								●	●	●
Dissolved oxygen			●			●			●	
Conductivity				●			●		●	●
Routine measurements		✓	✓	✓	✓	✓	✓	✓	✓	✓
Routine measurements with documentation					✓	✓	✓	✓	✓	✓
AQA with documentation					✓	✓	✓	✓	✓	✓
R&D: high resolution and precision					✓	✓	✓	✓	✓	✓
Control measurements		✓	✓	✓	✓	✓	✓	✓	✓	✓
LIMS connection					✓	✓	✓	✓	✓	✓
Quality assurance					✓	✓	✓	✓	✓	✓
Education		✓	✓	✓	✓	✓	✓	✓	✓	✓
Service		✓	✓	✓	✓	✓	✓	✓	✓	✓
Laboratory measurements		✓	✓	✓	✓	✓	✓	✓	✓	✓
Field measurements		✓	✓	✓	✓	✓	✓	✓	✓	✓
PC connection					✓	✓	✓	✓	✓	✓
Memory					✓	✓	✓	✓	✓	✓
USB interface					✓	✓	✓	✓	✓	✓
Graphic display			✓		✓	✓	✓	✓	✓	✓
		Compatible sensor system								
		Analogue electrodes								
pH electrodes	65	✓			✓			✓	✓	✓
ORP electrodes	73	✓			✓			✓	✓	✓
ISE electrodes	81							✓	✓	✓
Dissolved oxygen sensors	92		✓			✓			✓	✓
Conductivity cells	106			✓			✓		✓	✓
		pH 3110	Oxi 3205	Cond 3110	pH 3310	Oxi 3310	Cond 3310	pH/ION 3310	Multi 3320	pH/Cond 3320

see page 62 91 104 61 91 103 80 49 50

# ProfiLine 3320

Robust, waterproof multi-parameter instruments with extensive measuring functions for mobile use, available in the combinations pH, ORP, ISE, conductivity and pH, ORP, ISE, conductivity dissolved oxygen.

## Housing

IP 67 rated, water- and dust-tight housing for use outdoors and in facilities. Compatible with the SM Pro protective case.

## Display

Backlit BW graphic display, also for use in low light conditions for the simultaneous display of two measured parameters.

## Connectors

Waterproof socket field suitable for field use with two sensor connections.

DIN or BNC sockets for pH/mV sensors, with additional input for temperature sensor; 8-pin inputs for conductivity and oxygen electrodes.

Mini USB-B interface for data transfer and firmware update, socket for power supply.

## Keyboard

Silicon keyboard that can also be operated with gloves with raised keys, with tactile and acoustic feedback. Waterproof and easy to clean.

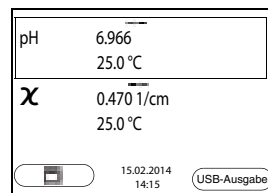
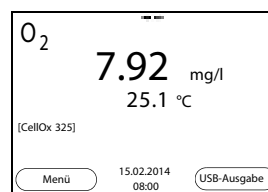
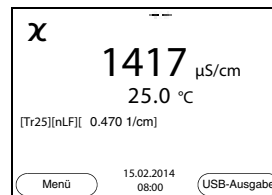
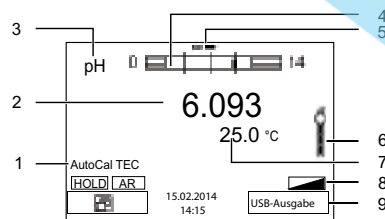

- 1 Status information (sensor)
- 2 Measurement value (with unit)
- 3 Measured parameter
- 4 Continuous measurement value control (CMC function; with pH measurement)
- 5 Channel display Plug position of the sensor
- 6 Sensor symbol (calibration evaluation)
- 7 Temperature measurement value (with unit)
- 8 Status information (meters)
- 9 Soft keys and date/time

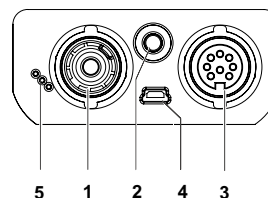

- 1 Connection for pH or ISE electrode
- 2 Reference electrode (with pH measurement)
- 3 Connection for conductivity or oxygen electrode
- 4 Mini USB-B interface for data transfer and firmware update
- 5 Service interface

Order information see page 50 (multi and pH/Cond)

# ProfiLine 3310

Robust, waterproof single-parameter meters with extensive measuring functions for mobile use, available in the variants pH, ORP, ISE, conductivity and dissolved oxygen.

## Housing

IP 67 rated Water- and dust-tight housing for use outdoors and in facilities. Compatible with the SM Pro protective case.

## Display

Backlit black/white graphic display, for use in challenging lighting conditions.

## Connectors

The 3310 has a waterproof DIN socket for pH/mV/ISE electrodes including reference and temperature sensor input, or a waterproof 8-pin socket for connecting WTW conductivity cells or dissolved oxygen sensors.

## Keyboard

Silicon keyboard that can be operated with gloves and has tactile and acoustic feedback. One piece molded design is waterproof and easy to clean.

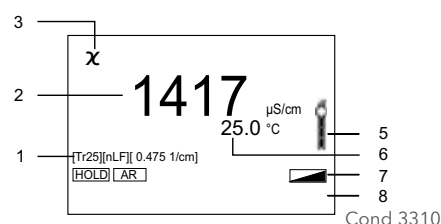
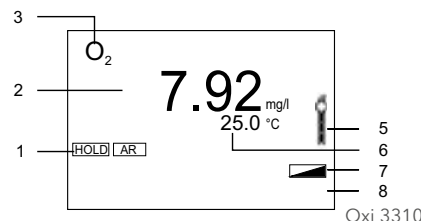
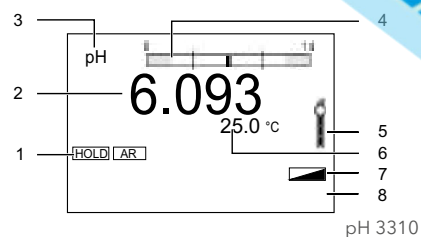

- 1 Status information
- 2 Measurement value (with unit)
- 3 Measured parameter
- 4 Continuous measurement value control (CMC function; with pH 3310)
- 5 Sensor symbol (calibration evaluation)
- 6 Temperature measurement value (with unit)
- 7 Battery display
- 8 Soft keys and date/time

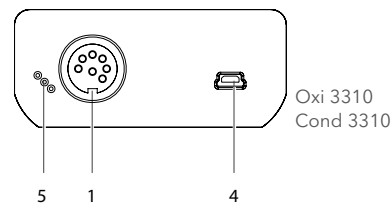
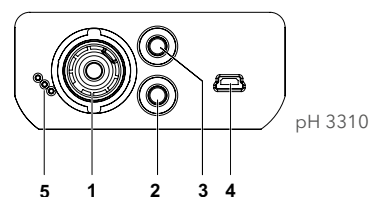

- 1 Connection for pH or ISE electrode or conductivity or dissolved oxygen sensor
- 2 Reference electrode (with pH measurement)
- 3 Temperature probe (with pH measurement)
- 4 Mini USB-B interface for data transfer and firmware update
- 5 Connection for power supply through AC adapter
- 6 Service interface

Order information see page 62 (pH), 90 (Oxi) 104 (Cond)

# ProfiLine 3110/3205

Easy to use, robust and waterproof meters for portable use, for pH/ORP or conductivity measurement. Ideal for occasional measurements without documentation.

## Housing

IP 67 rated Water- and dust-tight housing for use outdoors and in facilities. Compatible with the SM Pro protective case.

## Display

The 3110 meter have a clearly structured and easy-to-read segment display. The 3205 has a backlit BW graphic display, for use in challenging lighting conditions.

## Connectors

All sensor connections are IP 67 rated dust and waterproof. This ensures optimal signal transmission.

## Keyboard

Silicon keyboard that can be operated with gloves and has tactile and acoustic feedback. One piece molded design is waterproof and easy to clean.

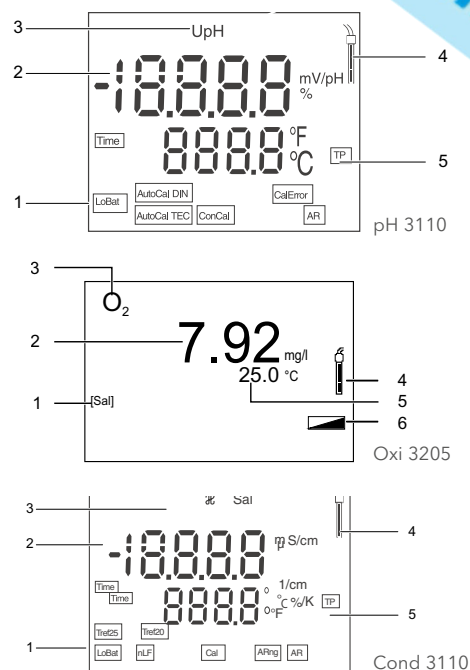

- 1 Status information
- 2 Measurement value (with unit)
- 3 Measured parameter
- 4 Sensor symbol (calibration evaluation)
- 5 Temperature measurement value (with unit)
- 6 Battery display

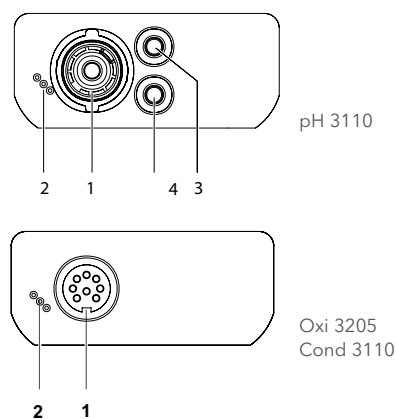

- 1 Connection for pH electrode or conductivity or dissolved oxygen sensor
- 2 Reference electrode (with pH measurement)
- 3 Temperature probe (with pH measurement)
- 4 Service interface

Order information see page  
62 (pH), 90 (Oxi) 104 (Cond)

# Multi-parameter measurement



## Content

- 23 Applications and meters overview
- 24 The IDS World
  - 26 IDS goes wireless - freely connected
  - 28 IDS pH electrodes
  - 32 IDS ORP electrodes
  - 33 IDS Optical dissolved oxygen sensor
  - 34 IDS Conductivity cells
  - 36 IDS Turbidity sensor
  - 38 IDS depth sonde MPP 930
- 40 Benchtop meters inoLab® Multi IDS - digital
- 42 Benchtop meters inoLab® - analogue
- 43 Portable meters MultiLine® IDS -digital
- 47 Portable meters ProfiLine analogue
- 51 Analogue sensors overview

# Applications and meters overview

pH, ORP potential, ion concentration, dissolved oxygen, conductivity, turbidity - if at least two of these main parameters have to be measured, a multi-parameter instrument can make sense.

	Digital			Analogue	Digital			Analogue		
	inoLab® Multi IDS			inoLab®	MultiLine IDS			ProfiLine		
	Multi 9630	Multi 9620	Multi 9310	pH/ION 7320	Multi 3630	Multi 3620	Multi 3510	Multi 3320	pH/Cond 3320	
✓ yes										
● yes										
✓ recommended										
✓ recommended for some applications										
– not recommended										
2 parameters simultaneously	✓	✓		✓	✓	✓		✓	✓	
3 parameters simultaneously	✓				✓					
pH/ORP	●	●	●	●	●	●	●	●	●	
Ion-selective measurement (ISE)	●	●		●				●	●	
Dissolved oxygen	●	●	●		●	●	●	●		
Conductivity	●	●	●		●	●	●	●	●	
Turbidity	●	●	●		●	●	●			
Routine measurements	✓	✓	✓	✓	✓	✓	✓	✓	✓	
Routine measurements with documentation	✓	✓	✓	✓	✓	✓	✓	✓	✓	
Wireless ready	✓	✓	✓		✓	✓	✓			
AQA with documentation	✓	✓	✓	✓	✓	✓	✓	✓	✓	
R&D - high resolution and precision	✓	✓	✓	✓	✓	✓	✓	✓	✓	
Control measurements	✓	✓	✓	✓	✓	✓	✓	✓	✓	
LIMS connection	✓	✓	✓	✓	✓	✓	✓	✓	✓	
Quality assurance	✓	✓	✓	✓	✓	✓	✓	✓	✓	
Education	✓	✓	✓	✓	✓	✓	✓	✓	✓	
Service	-	-	-	-	✓	✓	✓	✓	✓	
Laboratory measurements	✓	✓	✓	✓	✓	✓	✓	✓	✓	
Field measurement	-	-	-	-	✓	✓	✓	✓	✓	
Depth measurements	-	-	-	-	✓	✓	✓	-	-	
PC connection	✓	✓	✓	✓	✓	✓	✓	✓	✓	
Memory	✓	✓	✓	✓	✓	✓	✓	✓	✓	
USB interface	✓	✓	✓	✓	✓	✓	✓	✓	✓	
Graphic display			✓	✓			✓	✓	✓	
color graphic display	✓	✓			✓	✓				
Compatible sensor system										
IDS pH/ORP electrodes	28/32	✓	✓	✓		✓	✓	✓		
IDS Optical dissolved oxygen sensors	33	✓	✓	✓		✓	✓	✓		
IDS conductivity cells	34	✓	✓	✓		✓	✓	✓		
IDS Turbidity sensor	36	✓	✓	✓		✓	✓	✓		
IDS Depth Sonde	38					✓				
Analogue pH/ORP electrodes	65/73	*)	*)	*)		*)	*)	*)	✓	✓
Analogue ISE electrodes	81	*)	*)					✓		
Analogue dissolved oxygen sensors	92							✓		
Analogue conductivity cells	106							✓	✓	
	see page	40	40	41	56	44	45	46	49	50

\* with ada



# The WTW IDS world: Digital and innovative

The WTW IDS concept: Intelligent digital sensors for the standard parameters pH, conductivity, dissolved oxygen and turbidity.

The IDS system consists of two components: Digital sensors and matching portable and laboratory meters. The essential innovation is that the processing of the measured signals no longer takes place in the meters, but exclusively in the sensor.

## WTW IDS sensors: Digital, unique, distinctive

Based on the proven electrochemical WTW sensors, combined with state-of-the-art electronics, the new IDS sensors can store their serial number and calibration data in the sensor leerzeichen. This store information makes it easy to use one sensor on multiple meters.

However, the IDS sensors do not only store data but also process signals and thereby improve data quality. This also allows an evaluation of the sensor quality with pH electrodes by means of the QSC (Quality Sensor Control) function.

## Benefits of IDS

- Fail-safe measurement data by direct conversion of the raw signal in the sensor.
- All sensor, meter and user data are available for automatic documentation.
- Calibration data are stored directly in the sensor independently of the meter, and are therefore not lost.
- In addition to the measurement and calibration data, further additional information can be transmitted.

## Proven sensor technology

Based upon the tens of thousands of proven WTW sensors of the SenTix®, SensoLyt® and TetraCon® series, the IDS sensors provide more precision and reliability and cover almost any application.

## Freely connected - IDS goes wireless

Trend-setting for the digital laboratory: The meters of the IDS system can now also be expanded with wireless measured value transmission. New, universal wireless modules simplify work wherever cables and meters get in the way or there is simply too little space available.



НеварРеактив

НеваРеактив



Cond



pH

Cond



НеваРеактив

**I** as intelligent:

IDS sensors are intelligent. They log into the meter automatically, submit their description, serial number, calibration status and history, as well as all other parameters.

**D** as digital:

IDS sensors convert the sensitive measuring signals in the sensor head into digital signals and transmit them to the meter without interference and errors, no matter if using a cable or a wireless module.

**S** as sensor:

IDS sensors are based on proven and continuously enhanced WTW sensors. They cover almost any application, including pH, conductivity, dissolved oxygen or turbidity measurement.

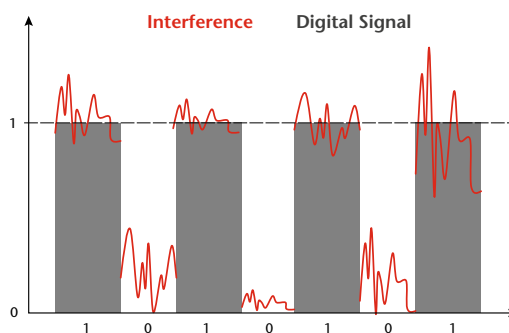

# IDS goes wireless: freely connected



## Measure with wireless sensors where ever you want!

The new wireless modules for IDS plug head sensors are simply plugged onto the sensor and automatically connect to the meter- safely and clearly. No cables, no tugging, just freedom to move where a meter would usually be in the way. Even with portable field measurements under difficult conditions, one hand is always free. Recording measurement values is as easy as simply pressing a button on the sensor module!

- **Wireless measurement**
- **Securely connected**
- **One module for all parameters**

## Wireless pH/ORP measurements

The pH measurement as the most important electrochemical measurement is carried out practically everywhere. And therefore most often in confined conditions in the laboratory, in the wet area, under laminar flow benches or fume hoods - just where cables are cumbersome to handle and meters are not desirable.

- Flexible - Plug head electrodes work with both cables as well as with wireless modules
- Easy processing of long measurements series in life science applications
- Penetration measurements in the food industry

## Wireless oxygen measurements

- BOD measurement in Karlsruher or Winkler bottles
- Full freedom of movement for sensor user
- Safe handling without cable tugging

## Wireless conductivity measurement

- Measurement under fume hoods, laminar flow benches or in confined spaces
- Series measurement in wastewater laboratory
- Flow-through measurements with groundwater pumping tests



### Unleash your sensor!

Plug the wireless module onto the IDS plug head sensor, confirm wireless connection - that's it!

All WTW-IDS sensors with plug head can be used.

### Intelligent module on the meter

The module on the IDS meter receives either one, two or three parameters simultaneously, depending on the number of available channels.

### Exchangeable modules multiple sensors

Exchange the module from sensor to sensor or use a separate module for each sensor.

Cascadable charging stations and complete sets are available.



## Technical specifications: IDS wireless modules

<b>Wireless transmission</b>	Bluetooth LE
<b>Range</b>	Approx. 10 m with intermediate walls and approx. 50 m line of sight
<b>Supply</b>	Rechargeable LiPo battery pack 230 mAh
<b>Operating times</b> (continuously)	IDS pH electrode 60 h IDS ORP electrode 60 h IDS conductivity cell 30 h (conductivity up to 1S/cm) IDS dissolved oxygen sensor 9 h Turbidity sensor 5 h
<b>Signal</b>	RGB-LED
<b>Protection class</b>	IP54
<b>Usable sensors</b>	All WTW IDS sensors with plug head

## Order information: IDS wireless modules

Model	Description	Order no.
<b>IDS WLM Kit</b>	Kit consisting of a wireless module for sensor and meter, USB charger and universal USB power supply	108144
<b>IDS WLM-S</b>	Wireless module for plug head sensor	108141
<b>IDS WLM-M</b>	Wireless module for IDS meter	108142
<b>WLM Charger</b>	USB charger for wireless modules, cascadable, (up to 5 units, with WTW power supply), scope of delivery without power supply	108143
<b>NT USB Universal</b>	Universal USB power supply	902872

## IDS pH electrodes

pH measurement shows a wide range of applications, from routine measurement in aqueous solutions up to special applications in a variety of media such as strong acid or alkaline solutions, with suspended solids or non-aqueous phases. The sample consistency can vary from liquid to firm, and measurements can be taken in a sheltered laboratory environment or outdoors in harsh conditions. Across all these variables, the range of IDS electrodes has the solution.

### IDS pH electrodes for water, wastewater and other aqueous samples

- SenTix® 940(-P)  
Low-maintenance pH electrode with robust plastic shaft with gel electrolyte
- SenTix® 945(-P)  
Low-maintenance, fast-response pH electrode with a gel reference system and three ceramic junctions for the laboratory
- SenTix® 950(-P)  
Robust, liquid-filled electrode with plastic shaft and ceramic junctions for portable field measurement
- SenTix® 980(-P)  
Precision pH electrode with platinum wire junction and glass shaft for the laboratory
- SensoLyt® 900-P  
Pressure-resistant pH electrode with polymer electrolyte for depth measurement



from left to right: the digital IDS sensors and wireless ready IDS plug head electrodes (1) SenTix® 940, (2) SenTix® 940-P, (3) SenTix® 945, (4) SenTix® 945-P, (5) SenTix® 950, (6) SenTix® 950-P, (7) SenTix® 980, (8) SenTix® 980-P, (9) SensoLyt® 900-P

**pH electrodes for special samples (suspensions, emulsions, high and low ion concentrations)**

- SenTix® HW-T 900(-P)  
Precision pH electrode with liquid electrolyte; adjustable split ring junction

**pH measurement in semi-solid or viscous samples**

- SenTix® Sp-T 900(-P)  
pH electrode with spear-shaped membrane for penetration measurements

**pH measurement in small vessels**

- SenTix® Micro 900(-P)  
Micro pH electrode with 5 mm shaft diameter and built-in Temperature probe

- Secure measurement values by means of signal processing in the sensor
- Easy electrode exchange thanks to calibration data stored in the sensor
- Sensor quality monitoring through QSC function



from left to right: the digital IDS special electrodes and wireless ready IDS plug head electrodes (1) SenTix® HW-T 900, (2) SenTix® HW-T 900-P, (3) SenTix® Sp-T 900(-P), (4) SenTix® Sp-T 900-P, (5) SenTix® Micro 900-P, (6) SenTix® Micro 900-P

Technical specifications and order information:

Low maintenance IDS pH electrodes with gel reference system

	SenTix® 940	SenTix® 940-3	SenTix® 940-P	SenTix® 945	SenTix® 945-P
<b>Order no.</b>	103740	103741	103760	103743	103764
<b>Measuring range pH</b>	0 ... 14 pH	0 ... 14 pH	0 ... 14 pH	0 ... 14 pH	0 ... 14 pH
<b>Temperature range</b>	0 ... + 80 °C	0 ... + 80 °C	0 ... + 80 °C	0 ... + 80 °C	0 ... + 80 °C
<b>Reference system</b>	Gel	Gel	Gel	Gel	Gel
<b>Membrane shape</b>	Cylinder	Cylinder	Ball	Ball	Cylinder
<b>Junction</b>	Fibre	Fibre	Fibre	3 x Ceramic	3 x Ceramic
<b>Shaft material</b>	Noryl	Noryl	Noryl	Glass	Glass
<b>Shaft length</b>	120 mm	120 mm	120 mm	120 mm	120 mm
<b>Shaft diameter</b>	12 mm	12 mm	12 mm	12 mm	12 mm
<b>Temperature probe</b>	NTC 30 kOhm	NTC 30 kOhm	NTC 30 kOhm	NTC 30 kOhm	NTC 30 kOhm
<b>Cable length</b>	1.5 m	3 m	1.5 ... 100 m, wireless	1.5 m	1.5 ... 100 m, wireless

Precision IDS pH electrodes with 3 mol/l KCl liquid reference

	SenTix® 950	SenTix® 950-P	SenTix® 980	SenTix® 980-P
<b>Order no.</b>	103750	103761	103780	103762
<b>Measuring range pH</b>	0... 14 pH	0... 14 pH	0... 14 pH	0... 14 pH
<b>Temperature range</b>	0 ... 80 °C	0 ... 80 °C	0 ... + 100 °C	0 ... + 100 °C
<b>Reference system</b>	KCl 3 mol/l Ag+ free	KCl 3 mol/l Ag+ free	KCl 3 mol/l Ag+ free	KCl 3 mol/l Ag+ free
<b>Membrane shape</b>	Cylinder	Cylinder	Cone	Cone
<b>Diaphragm</b>	Ceramic	Ceramic	Platinum wire	Platinum wire
<b>Shaft material</b>	PPE	PPE	Glass	Glass
<b>Shaft length</b>	120 mm	120 mm	120 mm	120 mm
<b>Shaft diameter</b>	12 mm	12 mm	12 mm	12 mm
<b>Temperature probe</b>	NTC 30 kOhm	NTC 30 kOhm	NTC 30 kOhm	NTC 30 kOhm
<b>Cable length</b>	1.5 m	1.5 m	1.5 m	1.5 ... 100 m, wireless

## Special IDS-pH electrodes

	SenTix® Micro 900	SenTix® Micro 900-P	SensoLyt® 900-P
<b>Order no.</b>	103751	103765	103748
<b>Measuring range pH</b>	0...14 pH	0...14 pH	0...12 pH
<b>Temperature range</b>	0 ... + 100 °C	0 ... + 100 °C	0 ... 60 °C
<b>Reference system</b>	KCl 3 mol/l Ag+ free	KCl 3 mol/l Ag+ free	Polymer
<b>Membrane shape</b>	Cylinder	Cylinder	Cylinder
<b>Junction</b>	Platinum wire	Platinum wire	Hole
<b>Shaft material</b>	Glass	Glass	Glass
<b>Shaft length</b>	65/130 mm	65/130 mm	120 mm
<b>Shaft diameter</b>	12/5 mm	12/5 mm	12 mm
<b>Temperature probe</b>	NTC 30 KOhm	NTC 30 KOhm	NTC 30 KOhm
<b>Cable length</b>	1.5 m	1.5 ... 100 m, wireless	1.5 ... 100 m, wireless

	SenTix® HW-T 900	SenTix® HW-T 900-P	SenTix® SP-T 900	SenTix® SP-T 900-P
<b>Order no.</b>	103753	103767	103752	103766
<b>Measuring range pH</b>	0...14 pH	0...14 pH	2...13 pH	2...13 pH
<b>Temperature range</b>	0 ... + 60 °C	0 ... + 60 °C	0 ... + 80 °C	0 ... + 80 °C
<b>Reference system</b>	KCl 3 mol/l Ag+ free	KCl 3 mol/l Ag+ free	Polymer	Polymer
<b>Membrane shape</b>	Cylinder	Cylinder	Spear	Spear
<b>Junction</b>	Split ring	Split ring	Hole	Hole
<b>Shaft material</b>	Glass	Glass	Glass	Glass
<b>Shaft length</b>	170 mm	170 mm	65/25 mm	65/25 mm
<b>Shaft diameter</b>	12 mm	12 mm	15/5mm	15/5mm
<b>Temperature probe</b>	NTC 30 KOhm	NTC 30 KOhm	NTC 30 KOhm	NTC 30 KOhm
<b>Cable length</b>	1.5 m	1.5 ... 100 m, wireless	1.5 m	1.5 ... 100 m, wireless

Accuracy IDS electronics  $\pm 0.004$  pH  
mV  $\pm 0.2$  mV

## Adapter for analogue pH electrodes

An adapter for all analogue pH electrodes with S7 plug head allows the connection of special electrodes to any IDS multi-parameter meters.



ADA S7/IDS



## IDS ORP electrodes

There are two different IDS ORP electrodes for the measurement, one for the standard applications in the laboratory and the other for field use.

- ⦿ **Secure measurement values by means of signal processing in the sensor**
- ⦿ **Integrated temperature probe NTC 30 kOhm for precise value documentation**
- ⦿ **Best possible GLP support through documentation of the sensor data**

**Universal ORP electrode with platinum round blank for laboratory applications**

- SenTix® ORP-T 900(-P )



**Pressure-resistant IDS platinum ORP electrode for measurement at depth**

- SensoLyt® ORP 900-P



### Technical specifications and order information: SenTix® IDS ORP electrodes

	SenTix® ORP-T 900	SenTix® ORP-T 900-P	SensoLyt® ORP 900-P
<b>Order no.</b>	103791	103763	103749
<b>Measuring range</b>	-1250.0 ... +1250.0 mV	-1250.0 ... +1250.0 mV	-1250.0 ... +1250.0 mV
<b>Work area °C</b>	0 ... 100 °C	0 ... 100 °C	- 5 ... 100 °C
<b>Reference electrolyte</b>	KCl 3 mol/l	KCl 3 mol/l	0 ... 60 °C
<b>Sensor</b>	Platinum	Platinum	Platinum
<b>Sensor form</b>	(4 mm)	(4 mm)	Ring
<b>Junction</b>	Ceramic	Ceramic	Hole
<b>Shaft material</b>	Glass	Glass	Glass
<b>Shaft length (±2 mm)</b>	120 mm	120 mm	120 mm
<b>Shaft-Ø (±0,5 mm)</b>	12 mm	12 mm	12 mm
<b>Temperature probe</b>	NTC 30 kOhm	NTC 30 kOhm	NTC 30 kOhm
<b>Cable length</b>	1.5 m	1.5 ... 100 m, wireless	1.5 ... 100 m, wireless, pressure-resistant up to 10 bar

Accuracy: electronics ± 0.2 mV

## IDS optical dissolved oxygen sensor

### Up-to-date standard compliant oxygen measurement

The most modern type of oxygen measurement: No chemicals, no electrolytes, instead a membrane cap with a special oxygen-selective dye. Measurement without maintenance effort, fast and precise - and recognised as per DIN ISO 17289: 2014-12 as standard method for measurement of dissolved oxygen.

- Saves time and money - low-maintenance and fast ( $t_{99} < 60s$ )
- Flow-free; with chamfered membrane
- Factory-calibrated sensor cap with smart chip

### Precise, flow-free optical IDS dissolved oxygen sensor for field and laboratory use.

- FDO® 925(-P)



### Technical specifications and order information: IDS dissolved oxygen sensors

	FDO® 925	FDO® 925-3	FDO® 925-P
Order no.	201300	201301	201306
Method	Optical	Optical	Optical
Response time $T_{99}$ (20 °C)	< 60 s	< 60 s	< 60 s
Measuring range concentration	0.00...20.00 mg/l ± 0,5 % of measured value	0.00...20.00 mg/l ± 0,5 % of measured value	0.00...20.00 mg/l ± 0,5 % of measured value
Measuring range saturation	0.0 ... 200.0 % ± 0,5 % of measured value	0.0 ... 200.0 % ± 0,5 % of measured value	0.0 ... 200.0 % ± 0,5 % of measured value
Measuring range partial pressure	0.0 to 400 hPa ± 0.5 % of measured value	0.0 to 400 hPa ± 0.5 % of measured value	0.0 to 400 hPa ± 0.5 % of measured value
Temperature	0 ... 50.0 °C ± 0.2 °C	0 ... 50.0 °C ± 0.2 °C	0 ... 50.0 °C ± 0.2 °C
Membrane shape	Chamfered	Chamfered	Chamfered
Shaft material	POM, stainless steel	POM, stainless steel	POM, stainless steel
Shaft length	140 mm	140 mm	140 mm
Length of sensor cap	15.3 mm	15.3 mm	15.3 mm
Cable length	1.5 m	3 m	1.5 ... 100 m, wireless, pressure-resistant up to 10 bar

## IDS conductivity cells

Two important parameters affect conductivity measurements: the cell constant and temperature compensation. Both must be specified manually when using different cells and analogue meters. With IDS conductivity cells, these data are transferred automatically - a clear advantage in measurement reliability!

- **Proven two or four electrode technology**
- **Easiest handling, robust design**
- **Broad application range from ultrapure water up to highly concentrated solutions**

### IDS graphite cells for universal use

- TetraCon® 925(-P)

Universal measuring cell for laboratory and field

### IDS Graphite measuring cells for special applications

- TetraCon® 925/C

Modified measuring cell with acid-proof PEEK head

- TetraCon® 925/LV(-P)

Measuring cell for small volumes and viscous samples

### Two electrode ultrapure water measuring cell

- LR 925/01(-P)

Two electrode measuring cell for conductivities up to 200 µS/cm



from left to right: the digital IDS sensors and wireless ready IDS plug head electrodes (1) TetraCon® 925, (2) TetraCon® 925-P, (3) TetraCon® 925 / C, (4) TetraCon® 925 / LV, (5) TetraCon® 925 / LV-P, (6) LR 925/01, (7) LR 925/01-P

## Specifications and order information: IDS conductivity cells Universal applications:

	TetraCon® 925	TetraCon® 925-3	TetraCon® 925-P
<b>Order number</b>	301710	301711	301716
<b>Type</b>	4 electrode	4 electrode	4 electrode
<b>Electrode material</b>	Graphite	Graphite	Graphite
<b>Flow through vessel</b>	-	-	-
<b>Shaft material</b>	Epoxy	Epoxy	Epoxy
<b>Shaft length</b>	120 mm	120 mm	120 mm
<b>Cell constant</b>	0.475 cm <sup>-1</sup>	0.475 cm <sup>-1</sup>	0.475 cm <sup>-1</sup>
<b>Diameter</b>	15.3 mm	15.3 mm	15.3 mm
<b>Measurement range</b>	1 µS/cm to 2000 mS/cm	1 µS/cm to 2000 mS/cm	1 µS/cm to 2000 mS/cm
<b>Temperature range</b>	0 to 100 °C	0 to 100 °C	0 to 100 °C
<b>Temperature sensor</b>	NTC 30 kOhm	NTC 30 kOhm	NTC 30 kOhm
<b>min./max. immersion depth</b>	36/120 mm	36/120 mm	36/120 mm
<b>Cable length</b>	1.5 m*	3 m	1.5 ... 100 m, wireless, pressure resistant up to 10 bar

## Special applications

	TetraCon® 925/C	TetraCon® 925/LV	TetraCon® 925/LV-P
<b>Order number</b>	301721	301718	301719
<b>Type</b>	4 electrode	4 electrode	4 electrode
<b>Electrode material</b>	Graphite	Graphite	Graphite
<b>Shaft material</b>	Epoxy	Epoxy	Epoxy
<b>Shaft length</b>	120 mm	120 mm	120 mm
<b>Cell constant</b>	0.475 cm <sup>-1</sup>	0.469 cm <sup>-1</sup>	0.469 cm <sup>-1</sup>
<b>Diameter</b>	15.3 mm	15.3 mm	15.3 mm
<b>Measurement range</b>	1 µS/cm ... 2000 mS/cm	1 µS/cm ... 2000 mS/cm	1 µS/cm ... 2000 mS/cm
<b>Temperaturbereich</b>	0 ... 100 °C	0 ... 100 °C	0 ... 100 °C
<b>Temperature sensor</b>	NTC 30 kOhm	NTC 30 kOhm	NTC 30 kOhm
<b>min./max. immersion depth</b>	36/120 mm	16/120 mm	
<b>Cable length</b>	1.5 m	1.5 m	1.5 ... 100 m, wireless, pressure resistant up to 10 bars

## Ultra pure water applications

	LR 925/01	LR 925/01-P
<b>Order number</b>	301720	301722
<b>Electrode material</b>	Stainless steel V4A	Stainless steel V4A
<b>Flow through vessel</b>	Glass	Glass
<b>Shaft material</b>	Stainless steel V4A	Stainless steel V4A
<b>Shaft length</b>	120 mm	120 mm
<b>Cell constant</b>	0.1 cm <sup>-1</sup>	0.1 cm <sup>-1</sup>
<b>Diameter</b>	12 mm	12 mm
<b>Measurement range</b>	0.01 ... 200 µS/cm	0.01 ... 200 µS/cm
<b>Temperature range</b>	0...100 °C	0...100 °C
<b>Temperature sensor</b>	NTC 30 kOhm	NTC 30 kOhm
<b>Volume</b>	17 ml (without sensor)	17 ml (without sensor)
<b>min./max. immersion depth</b>	30/120 mm	30/120 mm
<b>Cable length</b>	1.5 m	1.5 ... 100 m, wireless

## IDS turbidity sensor

The new VisoTurb® 900-P is an infrared turbidity sensor for direct measurement in the medium for laboratory and mobile applications. Application areas are surface water, pumping tests, groundwater, monitoring of filters in food and beverage production, and anywhere turbidity needs to be measured quickly and easily.

The VisoTurb® 900-P conforms to DIN ISO 27027 with infrared light at a scattering angle of 90°.

- **Handy turbidity sensor with titanium shaft**
- **Simple 2- or 3-point calibration**
- **Suitable for multi-parameter measurement with MPP-IDS**

### Technical specifications and order information: IDS turbidity sensor

	<b>VisoTurb® 900-P</b>
<b>Order no.</b>	600700
<b>Parameter</b>	FNU or NTU
<b>Temperature</b>	Operating temperature: -5 to 50 °C
<b>Measuring range</b>	0 to 4000 FNU
<b>Accuracy</b>	0 to 999 FNU: 0.3 FNU or ±2 %, (depending which is larger) 1000 to 4000 FNU: ± 5 % of the value
<b>Wavelength of the exciting light</b>	860 nm ± 15 nm
<b>Measurement angle</b>	90°
<b>Pressure resistance (IP 68)</b>	10 bar
<b>Connection</b>	1.5 ... 100 m, wireless



VisoTurb® 900-P



## Accessories for IDS sensors

### Protection for IDS sensors

Measurements in the field required robust meters and sensors. There are a wide range of accessories available to further enhance the protection of your instruments.

Protection accessories are available to avoid damaging sensors during usage in harsh conditions such as in floodwater, boreholes, rivers containing debris, or in channels and tanks.

The range extends from plastic protection for pH laboratory electrodes used in mobile application in the field and in production up to a solid stainless steel version, which simultaneously acts as a sinker.



#### A pHLab/K:

- Protection for precision pH electrodes with 120 mm glass shaft
- Significantly reduces the risk of breakage when measuring in the process and in the field

#### A 925/K, A 925/K-P and A 925/S-P:

- Protection for tough field use of pressure-resistant IDS sensors
- Version for IDS sensors with and without plug head

### Flow-through measurement in the field

For groundwater measurement, there is a flow-through vessel with the possibility to measure up to three parameters simultaneously. Pump measurement in the field is made easier with a tripod for uneven ground or the pole support. The hose connections are designed for standard 19 mm (3/4") garden hoses.



D 3Sen for mast assembly



D 3Sen in a tripod ground stand

## Order information: Accessories for IDS sensors

Model	Description	Order no.
A 925-P/K	Protection for IDS field sensors with plug head, plastic	903839
A 925-P/S	Protection for IDS field sensors with plug head, stainless steel	903840
A pHLab/K	Protection for pH and ORP electrode with a length of 120 mm	903841
D 3Sen	Flow-through vessel in a tripod ground stand for up to three pH, ORP, oxygen or conductivity sensors (also IDS versions)	903842

Accessories price list or [www.WTW.com](http://www.WTW.com)

## Depth sonde MPP 930 IDS



- **Measures pH, conductivity, dissolved oxygen and turbidity - up to three main parameters simultaneously, plus depth and temperature**
- **Barometric pressure-compensated depth measurement for accurate results**
- **Profile measurement without tangled cables - special cable reel with sliding contacts available**

MPP 930-pH/FDO®/Cond-Kit

Multi-parameter probe for the simultaneous measurement of up to three of the following parameters. Dissolved oxygen (optical), pH or ORP, conductivity and turbidity. A built-in pressure sensor supplies the depth reading. Each sensor includes self contained temperature compensation.

Typical applications include limnological studies up to a depth of 100 meters, but also measurements in wells, dump site monitoring and much more.

The Multi 3630 IDS is required for measurement. The probe is available in a kit with sensors.



### IDS depth profile measurement

Depth profile measurement with the WTW IDS system: A temperature- and barometric pressure-compensated pressure sensor integrated in the depth sonde combines dissolved oxygen, pH or ORP and conductivity with exact depth indication.

### Novel plug head system

No Twisting. One click and the connection to the MPP is closed in a pressure-resistant, tensile-resistant and data-safe manner. With thin and tear-resistant cables in different lengths.

### Special cable reel with sliding contacts

Unwind the cable and conveniently read the data on the meter: This is enabled by the optional cable reel with sliding contacts for up to 100m of cable.

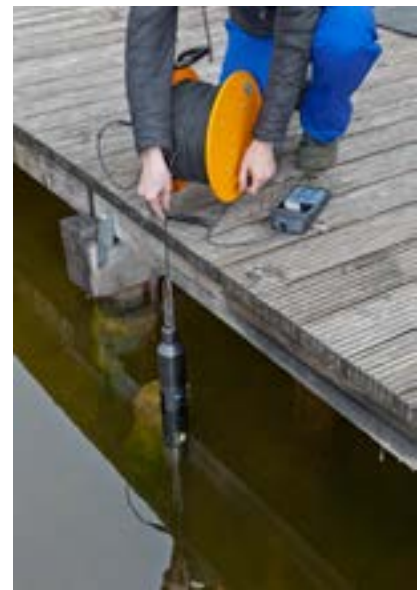

## Technical specifications: IDS depth sonde

	MPP 930 IDS
<b>Length</b>	500 mm
<b>Diameter</b>	70 mm
<b>Weight</b>	3.0 kg
<b>Measuring range depth measurement</b>	0.50 to 100 m
<b>Dissolution</b>	0.05 m
<b>Accuracy</b>	± 0.25 m at 100 m
<b>Number of the sensor plug locations</b>	3

## Order information: IDS depth sonde

Model	Description	Order no.
MPP 930-pH/FDO®/C	Digital multi-parameter depth sonde, for Multi 3630 IDS, in the kit with pressure-resistant digital pH, oxygen and conductivity sensors, in a field carrying case including accessories.	401206

For accessories, see price list or [www.WTW.com](http://www.WTW.com)



# Digital multi-parameter benchtop meters

inoLab® Multi 9630, 9620 IDS: measure securely



inoLab® Multi 9630

- Three or two universal measuring channels
- Digital sensor recognition
- Prepared for IDS wireless modules



The inoLab® Multi 9630 IDS and inoLab® Multi 9620 IDS are the new, wireless-ready, high-performance, three-channel and dual-channel digital benchtop meters with a glass-protected color graphic display, high-quality die-cast zinc base and antibacterial keyboard. With these multi channel instruments, several parameters can be measured and documented simultaneously.

The new MultiLab® user enables the assignment of individual user rights for life science and other regulated applications.

## Measurement safety

- The digital signal transfer eliminates interference, safely allocates calibration data, simply transmits sensor data
- The intelligent sensor evaluation (QSC) provides information about the actual state of the electrode and therefore increases the operational safety
- Secure wireless connection by clear allocation of sensor and meter

## GLP/AQA compliant documentation

- Automatic, digital capture of all sensor data for the clear traceability of the measured values
- Activatable user management with definable user rights for the safe allocation of users, measurement results and sample
- Data output on PC, USB memory stick or printer
- ISE measurement with increment methods

## Flexible and high performance

- Any combination of parameters
- Backlit graphic display with CMC, QSC and channel display
- Meter for analogue pH/ISE/ORP electrodes
- Memory with 10,000 entries

## inoLab® Multi 9310 IDS: determine securely



inoLab® Multi 9630

- One universal measuring channel
- Digital sensor recognition
- IDS wireless module compatible



The Lab 9310 with a digital measuring channel is very suitable to enter the world of digital multi-parameter measurement using IDS sensors. The IDS technology allows optimized measurements and efficient documentation in the simplest manner.

The inoLab® Multi 9310 IDS is compatible with the wireless IDS modules.

### GLP/AQA compliant documentation

- Automatic, digital recording of all sensor data for the clear traceability of the measured values
- Activatable user management with definable user rights for the safe allocation of user and measurement result
- Transmission of all data in \*.csv format via USB interface to PC; if desired, formatted transfer to Excel (MultiLab® Importer, included in the delivery or as a download).
- Output directly into the meter possible; via optional built-in printer.



## Technical specifications: Digital multi-parameter benchtop meters

	inoLab® Multi 9630 IDS	inoLab® Multi 9620 IDS	inoLab® Multi 9310 IDS
<b>Parameter</b>	pH, mV, O <sub>2</sub> (saturation, concentration, partial pressure), conductivity (specific resistance, salinity, TDS), temperature, turbidity		
<b>Digital/IDS sensors</b>	●	●	●
<b>Universal measuring channels</b>	3	2	1
<b>Analogue pH/ORP and ISE sensors</b>	ADA 94 pH/IDS	ADA 94 pH/IDS	ADA S7/IDS (optional; no ISE measurement possible)
<b>Temperature compensation</b>	All except for ORP	All except for ORP	All except for ORP
<b>Calibration points:</b>			
<b>pH measurement</b>	1-5	1-5	1-5
<b>ISE measurement</b>	2-7 (Adapter necessary)	2-7 (Adapter necessary)	-
<b>Dissolved oxygen measurement</b>	1	1	1
<b>Conductivity measurement</b>	1	1	1
<b>Turbidity measurement</b>	3	3	3
<b>Calibration timer</b>	1 - 999 days	1 - 999 days	1 - 999 days
<b>Memory capacity</b>	Manual: 500 data sets automatic: 10,000 data sets	Manual: 500 data sets automatic: 10,000 data sets	Manual: 500 data sets automatic: 4,500 data sets
<b>Logger</b>	●	●	●
<b>Interface</b>	USB-A, Mini USB-B	USB-A, Mini USB-B	Mini USB-B
<b>GLP/AQA support</b>	●	●	●
<b>Display</b>	Color graphic	Color graphic	BW graphic
<b>Printer option</b>	External	External	Yes
<b>Miscellaneous</b>	Antibacterial keypad, QSC, CMC	Antibacterial keypad, QSC, CMC	CMC, QSC
<b>Power Supply</b>	Universal power supply	Universal power supply	Universal power supply, battery (4 x 1.5 V AA Type)

## Order information: Digital multi-parameter benchtop meters

Model	Description	Order no.
<b>inoLab® Multi 9310 SET C</b>	Digital multi-parameter laboratory meter, wireless ready, in set included IDS sensors, electrode SenTix® 940, IDS conductivity cell TetraCon® 925, accessories	1FD35C
<b>inoLab® Multi 9620 SET C</b>	Professional digital multi-parameter benchtop meters, wireless ready. With two universal measuring channels for pH/mV/ISE, dissolved oxygen, turbidity and conductivity, digital IDS pH electrode SenTix® 980, IDS conductivity cell TetraCon® 925, accessories	1FD56C
<b>inoLab® Multi 9630 SET K</b>	Professional digital multi-parameter benchtop meters, wireless ready. With three universal measuring channels for pH/mV/ISE, dissolved oxygen and conductivity, digital IDS pH electrode SenTix® 980, optical IDS dissolved oxygen sensor FDO® 925. IDS conductivity cell TetraCon® 925, accessories	1FD57K

For additional sets, see price list or [www.WTW.com](http://www.WTW.com)

## Benchtop meters for analogue sensors

### inoLab® pH/ION 7320 – reliable ion concentration measurement and documentation

The inoLab® pH / ION 7320 is perfectly suited for precision measurement and automatic GLP/AQA compliant documentation in quality laboratories of all industries. Also available with optionally installed printer



inoLab® pH/ION 7320P  
(with built-in printer)

see page 78

# Digital multi-parameter portable meters

## MultiLine IDS

The robust and field-suitable measuring instruments are waterproof and dust-proof according to IP 67. They have a silicon keypad made of a single cast and can be cleaned easily with a soft brush under a water jet. They support the GLP documentation with meter and sensor data, and with the new MultiLab® User user management, individual user rights can also be assigned. By being prepared for optional wireless measurement, they save space and ensure full freedom of movement.

MultiLine® INTELLIGENT DIGITAL SENSORS

3 year warranty IP 67 CE



All IDS portable meters are available in application-specific carrying case kits with sensors and accessories.



### Modern communication

Two field-suitable waterproof USB interfaces for connecting memory sticks or selected printers and for data transfer to PC or laptop with MultiLab® Importer (For Multi 3630/3620 IDS).

## Technical specifications: Digital multi-parameter portable meters

MultiLine®	Multi 3630 IDS	Multi 3620 IDS	Multi 3510 IDS
<b>Parameter</b>	pH, mV, O <sub>2</sub> (saturation, concentration, partial pressure), Conductivity (spec. resistance, salinity, TDS), Temperature, Turbidity, Depth*	pH, mV, O <sub>2</sub> (saturation, concentration, partial pressure), Conductivity (spec. resistance, salinity, TDS), Temperature, Turbidity	pH, mV, O <sub>2</sub> (saturation, concentration, partial pressure), Conductivity (spec. resistance, salinity, TDS), Temperature, Turbidity
<b>Digital/ IDS sensors</b>	●	●	●
<b>Universal measuring channels</b>	3	2	1
<b>Memory capacity</b>	Manual: 500 data sets Automatic: 10,000 data sets	Manual: 500 data sets Automatic: 10,000 data sets	Manual: 500 data sets Automatic: 4,500 data sets
<b>Data logger</b>	Manual, time-controlled	Manual, time-controlled	Manual, time-controlled
<b>Interface</b>	USB-A, Mini USB-B	USB-A, Mini USB-B	Mini USB-B
<b>Display</b>	Color graphic	Color graphic	Graphic, BW
<b>Power Supply</b>	Power supply with charging function, 4 NiMH batteries (AA type), USB	Power supply with charging function, 4 NiMH batteries (AA type), USB	4 Alkaline batteries, USB
<b>Protection class</b>	IP 67	IP 67	IP 67

\* with MP100 IDS

## Multi 3630 IDS: The all-rounder for pH/ORP, conductivity, dissolved oxygen and turbidity



MultiLine® Multi 3630 IDS

- **Fail safe measurement due to galvanic isolation of the two inputs**
- **Simultaneous proof reading of up to three parameters through brilliant color graphic display**
- **Prepared for the use with a MPP IDS depth sonde**

The Multi 3630 IDS with three universal measurement channels works with all WTW IDS pH, ORP, dissolved dissolved oxygen sensors, conductivity cells and turbidity sensors, whether tethered or wireless.

### Reliable measurements

- Any combination of equal and different parameters
- Cable lengths up to 100 m for all parameters
- Backlit color graphic display with CMC, QSC and channel display
- Secure wireless connection between sensor and meter

### GLP/AQA compliant documentation

- Automatic, digital logging of all sensor data for the clear traceability of the measured values
- Activatable user management with definable user rights for secure provisioning of users, measurement results and samples

### Flexible and high performance

- The digital signal transfer eliminates interference, safely allocates calibration data, simply transmits sensor data
- The intelligent sensor evaluation (QSC) provides information about the actual state of the electrode and therefore increases the operational safety
- Memory with 10,000 entries
- Data output on PC, USB memory stick or printer
- Pluggable adapter for analogue pH/ORP electrodes
- Connection of a MPP IDS depth sonde possible

## Multi 3620 IDS: Simultaneous measurement of two parameters



MultiLine® Multi 3620 IDS

- **Fail safe measurement due to galvanic isolation of the two inputs**
- **Clear display of one or two measurement parameters with bright color display**
- **Simple to operate with clear menu structure**

### Reliable measurements

- Any combination of available measurement parameters
- Cable lengths up to 100 m for all parameters
- Backlit color graphic display with CMC, QSC and channel display
- Secure wireless connection by clear allocation of sensor and meter

### GLP/AQA compliant documentation

- Automatic, digital logging of all sensor data for the clear traceability of the measured values
- Activatable user management with definable user rights for the safe allocation of users, measurement results and sample

### Flexible and high performance:

- The digital signal transfer eliminates interference, safely allocates calibration data, simply transmits sensor data
- The intelligent sensor evaluation (QSC) provides information about the actual state of the electrode and therefore increases the operational safety
- Memory with 10,000 entries
- Data output on PC, USB memory stick or printer
- Pluggable adapter for analogue pH/ORP electrodes

## Multi 3510 IDS: Multi-parameter measurement made simple



MultiLine® Multi 3620 IDS

- **Sequential multi-parameter measurement**
- **Memory for 4500 automatic and 500 manual inputs for data collection in the field**
- **Reliable and robust for mobile use**
- **Easy-to-read backlit S/W graphic display**

The Multi 3510 IDS is a perfect entry-level meter for IDS multi-parameter measurement. All WTW IDS pH, ORP, dissolved oxygen sensors, conductivity cells and turbidity sensors can be connected to the universal measuring channel, either with cable or with wireless module.

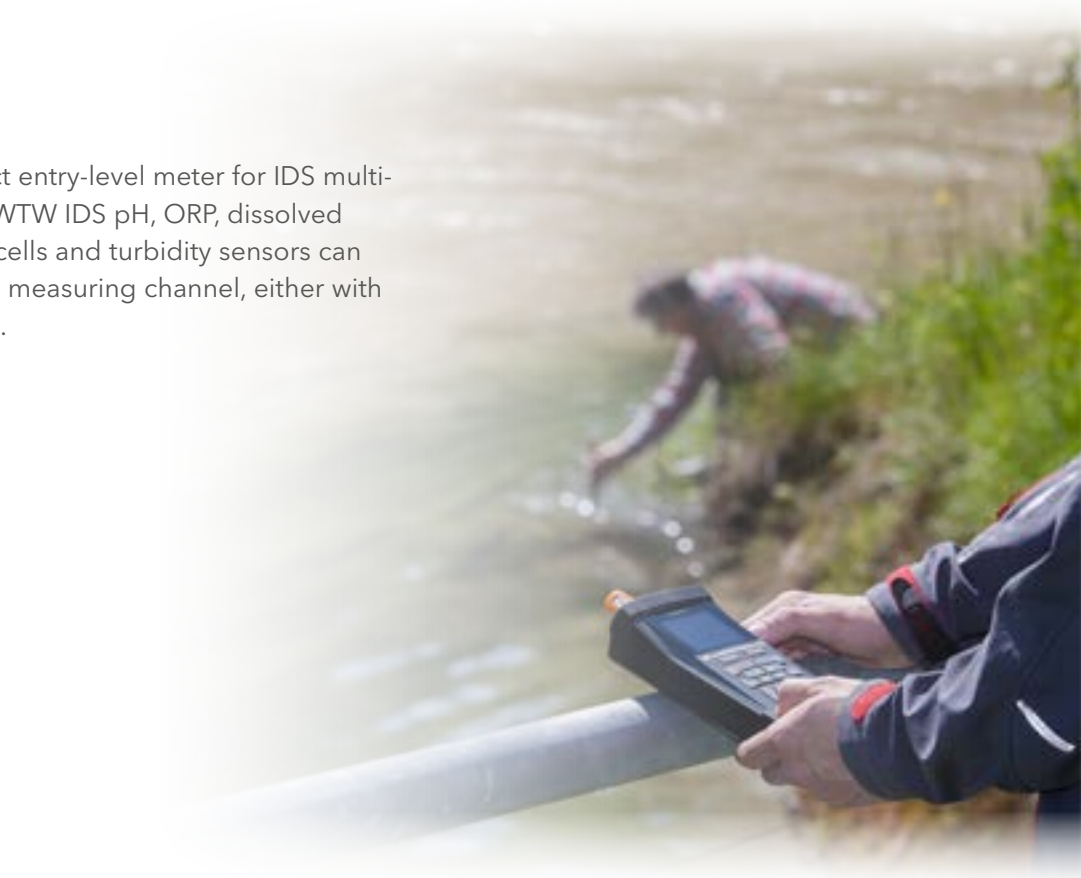

## Order information: Digital multi-parameter portable meters

Model	Description	Order no.
<b>Multi 3510 IDS SET 4</b>	Professional multi-parameter portable meter for IDS electrodes, wireless ready in a carrying case kit with optical dissolved oxygen sensor FDO® 925, accessories.	2FD354
<b>Multi 3620 IDS SET C</b>	Professional, digital multi-parameter portable meter for field measurement, with two universal measuring channels, wireless ready, set in a carrying case with IDS sensors: digital pH electrode SenTix® 940, digital conductivity cell TetraCon® 925, accessories	2FD56C
<b>Multi 3630 IDS SET F</b>	Professional, digital multi-parameter portable meter for field measurement, with three universal measuring channels, wireless ready, set in field carrying case with IDS sensors: digital pH electrode SenTix® 940, digital conductivity cell TetraCon® 925, optical dissolved oxygen sensor FDO® 925, accessories	2FD57F

For additional sets, see price list or [www.WTW.com](http://www.WTW.com)

# ProfiLine multi-parameter portable meters for analogue sensors

Profiline is a line of robust and watertight multi-parameter portable meters for analogue sensors. They measure simultaneously from a selection of different parameters with a maximum of 2 sensors.

3 year warranty

IP 67

CE



pH/ION 3310

## pH/ION 3310

A portable specialist for pH/mV/ISE measurement. You can find more information in the chapter "Ion-selective measurement".

see page 80

НеваРеактив





## Technical specifications: Multi-parameter portable meters for analogue sensors

ProfiLine		pH/Cond 3320 and Multi 3320		
pH measurement	Measurement Range pH	-2.0 ... 20.0 ±0.1 pH -2.00 ... 20.00 ±0.01 pH -2.000 ... 19.999 ±0.005 pH		
	Measurement range mV	± 1200.0 mV ± 0.3 mV ± (2500 ± 1) mV		
	Measurement range ISE	Conc.	0.000 ... 9.999	
		(mg/l, µmol/l, mg/kg, ppm, %)	10.00 ... 99.99 100.0 ... 999.9 1000 ... 999999	
	Measurement range temperature	-5.0 ... 105.0 °C ± 0.1 °C		
	CMC	Yes		
	Calibration	1-, 2-, 3-, 4-, 5-point calibration WTW Technical, DIN-, NIST- as well as further 22 buffer sets ISE 2 ... 7-point calibration, also non-linear		
Conductivity measurement	Measurement range conductivity	0.00 ... 1000 mS/cm ± 0.5 % of measured value		
	Measurement range specific resistance	1 Ohm/cm ... 199.9 MOhm/cm (dependent on cell constant)		
	Cell constants	Fixed:	0.01 cm <sup>-1</sup>	
		Additionally	0.000 ... 1.999 µS/cm, K= 0.01 cm <sup>-1</sup> 0.00 ... 19.99 µS/cm, K= 0.1 cm <sup>-1</sup>	
		With calibration:	0.450 to 0.500 cm <sup>-1</sup> 0.800 ... 0.880 cm <sup>-1</sup>	
		Adjustable:	0.090 ... 0.110 cm <sup>-1</sup> 0.250... 25.000 cm <sup>-1</sup>	
	Salinity	0.0 ... 70.0 (as per IOT)		
	TDS	1 ... 1999 mg/l, 0 to 199.9 g/l		
	Measurement range temperature	-5.0 ... 105.0 °C ± 0.1 °C		
	Sensor plug	8 pins		
	Calibration (conductivity)	1-point	0.01 mol/l KCl 1413 µS/cm at 25°C	
	T <sub>ref</sub>	20 °C/25 °C		
Temperature compensation	None, nF, 0.000 ... 10.000 %/K			

### Additionally with Multi 3320:

Oxygen measurement	Measurement range dissolved oxygen	Concentration*	0.00 ... 20.00 mg/l ± 0,5 % measured value 0 ... 90 mg/L ± 0,5 % of measured value
		Saturation *	0.0 ... 200.0 % ± 0,5 % of measured value 0 ... 600 % ± 0.5 of measured value
		Partial pressure*	0 ... 200.0 hPa, 0 ... 1250 hPa, each ± 0,5% of measured value
		Measurement range temperature	0.0 ... 50.0 °C ± 0.1 °C
Calibration	CellOx / DurOx with OxiCal calibration vessels, in addition against external standard		
Air pressure compensation	Through built-in sensor		

### General data

Calibration memory	Retrievable up to 10 calibrations
AutoRead	Can be switched automatically/manually
Display Celsius/Fahrenheit	Yes
Display	LCD graphics -, backlit
Data memory	500 manual, 5000 automatic
Logger	Manual/time-controlled
Waterproof	IP 67
Interface	USB slave
Power Supply	4 x 1.5 V AA or 4 x 1,2 V NiMH battery pack
Permissible operation	Up to 800 h without or 100 h with illumination

\* depends on sensor

All values ± 0.1 position after decimal point

## Multi 3320



ProfiLine Multi 3320

- ⦿ **Extensive measurement functions for pH, ORP, ISE, conductivity and dissolved oxygen**
- ⦿ **Built-in memory and data logger for recording measurement series**
- ⦿ **Backlit graphic display with simultaneous display of the measurement values**

The Multi 3320 measures pH, ORP, ISE conductivity and dissolved oxygen (electrochemical). It is an ideal meter for environmental applications like groundwater and surface water measurement, aquaculture, as well as in a wastewater treatment plant and much more. Also suitable for process applications where dissolved oxygen is important. All analogue WTW pH/ORP electrodes, combined ISE electrodes, conductivity cells and galvanic dissolved oxygen sensors can be connected to the meter.

### Clear measurements

- Backlit graphic display with CMC function for pH
- Measure two parameters simultaneously

### GLP/AQA compliant documentation

- GLP-supporting data acquisition with date, time, ID number

### Flexible and high performance:

- pH, ORP, ISE, conductivity and dissolved oxygen measurement
- Memory with 5,000 entries
- Data output on the PC

## pH/Cond 3320



ProfiLine pH/Cond 3320

- **Two inputs for the simultaneous measurement of pH/mV/ISE and conductivity**
- **Backlit graphic display for the simultaneous display of the measured values**
- **Perfect for monitoring process applications**

The pH/Cond 3320 measures pH, ORP, ISE and conductivity. It is used almost everywhere - from process chemistry via life science, food and beverage to the pharmaceutical industry (measurement of pH and conductivity according to pharmacopoeia). It is a handy and robust meters, even for demanding applications which require documentation.

### Reliable measurements

- Backlit graphic display with CMC function for pH
- Measure two parameters simultaneously

### GLP/AQA compliant documentation

- GLP-supporting data acquisition with date, time, ID number

### Flexible and high performance:

- pH, ORP, ISE and conductivity measurement
- Memory with 5,000 entries
- Data output on the PC

## Order information: Multi-parameter portable meters for analogue sensors

Model	Description	Order no.
<b>pH/Cond 3320 SET 2</b>	Professional pH/conductivity meter with 2 inputs, meter in a carrying case with pH electrode SenTix® 41, conductivity cell TetraCon® 325 and accessories	2EA312
<b>Multi 3320 SET 1</b>	Professional pH/dissolved oxygen/conductivity meter with 2 inputs, meter in a field carrying case with pH - electrode SenTix® 41, dissolved oxygen sensor CellOx® 325, conductivity cell TetraCon® 325 and accessories	2FA311

Further information: see price list or [www.WTW.com](http://www.WTW.com)

# Analogue sensors

## pH electrodes

WTW pH electrodes include a wide variety of application-oriented models that cover all aspects of pH measurement.

see page 65



## ORP electrodes

The ORP measurement is a determination of potentials that result from reactions on the metal surface of the electrodes. Each multi-parameter meter with pH function also measures the ORP voltage.

see page 73



## ISE electrodes

Ion-selective measurement is a method to determine concentrations of specific ions in a quantitative manner.

see page 81



## Dissolved oxygen sensors

Dissolved oxygen is an important parameter in biologic and technical processes, for example in corrosion prevention applications. The Multi 3320 has the possibility of electrochemical oxygen measurement.

see page 92



## Conductivity cells

WTW has a large selection of analogue conductivity cells for all applications. Highest mechanical precision in manufacturing ensures unsurpassed quality.

see page 106



# pH measurement

Невареактив



---

## Content

- 53 *Applications and meters overview*
- 54 *pH benchtop meters*
  - 54 *inoLab® Multi IDS - digital*
  - 55 *inoLab® pH - analogue*
- 58 *Portable pH meters*
  - 58 *MultiLine® IDS - digital*
  - 59 *ProfiLine - analogue*
- 63 *pH electrodes*
  - 63 *IDS electrodes - digital*
  - 64 *SenTix® pH electrodes - analogue*
- 68 *Calibration and maintenance accessories*

Невареактив

# Applications and meters overview

The pH value is defined in water and predominantly aqueous solutions and is one of the three most common parameters measured in the laboratory after weighing and temperature measurement. It has great importance for biological, chemical and biochemical processes, as well as for the properties of different products.

✓ yes

● yes

✓ recommended

✓ recommended for some applications

– not recommended

	Digital			Analogue			Digital			Analogue						
	Benchtop pH meters						Portable pH meters									
	inoLab® IDS			inoLab®			MultiLine® IDS			ProfiLine						
	Multi 9630	Multi 9620	Multi 9310	pH/ION 7320	pH 7310	pH 7110	Multi 3630	Multi 3620	Multi 3510	Multi 3320	pH/Cond 3320	pH/ION 3310	pH 3310	pH 3110	pHotoFlex® pH	
2 parameters simultaneously	✓	✓		✓			✓	✓		✓	✓					
3 parameters simultaneously	✓						✓									
pH	●	●	●	●	●	●	●	●	●	●	●	●	●	●	●	
ORP	●	●	●	●	●	●	●	●	●	●	●	●	●	●	●	
ISE (pH/ION function)	●	●		●						●	●	●				
Ion-specific measurement programs	●	●		●												
Additional parameters	●	●	●				●	●	●	●	●				●	
Routine measurements	✓	✓	✓	✓	✓	✓	✓	✓	✓	✓	✓	✓	✓	✓	✓	
Routine measurements with documentation	✓	✓	✓	✓	✓	–	✓	✓	✓	✓	✓	✓	✓	–	✓	
AQA with documentation	✓	✓	✓	✓	✓	–	✓	✓	✓	✓	✓	✓	✓	–	✓	
R&D High resolution and precision	✓	✓	✓	✓	✓	–	✓	✓	✓	✓	✓	✓	✓	–	✓	
Control measurements	✓	✓	✓	✓	✓	–	✓	✓	✓	✓	✓	✓	✓	–	✓	
LIMS connection	✓	✓	✓	✓	✓	–	✓	✓	✓	✓	✓	✓	✓	–	✓	
Quality assurance	✓	✓	✓	✓	✓	–	✓	✓	✓	✓	✓	✓	✓	–	✓	
Education	✓	✓	✓	✓	✓	✓	✓	✓	✓	✓	✓	✓	✓	✓	✓	
Service	–	–	–	–	–	–	✓	✓	✓	✓	✓	✓	✓	✓	✓	
Laboratory measurements	✓	✓	✓	✓	✓	✓	✓	✓	✓	✓	✓	✓	✓	✓	✓	
Field measurements	–	–	–	–	–	–	✓	✓	✓	✓	✓	✓	✓	✓	✓	
Depth measurements	–	–	–	–	–	–	✓	✓	✓	–	–	–	–	–	–	
PC connection	✓	✓	✓	✓	✓		✓	✓	✓	✓	✓	✓	✓		✓	
Memory	✓	✓	✓	✓	✓		✓	✓	✓	✓	✓	✓	✓		✓	
USB interface	✓	✓	✓	✓	✓		✓	✓	✓	✓	✓	✓	✓		✓	
Graphic display				✓	✓	✓			✓	✓	✓	✓	✓		✓	
Color graphic display	✓	✓					✓	✓								
Compatible sensor system																
Digital IDS electrodes																
IDS pH electrodes	28	✓	✓	✓			✓	✓	✓							
IDS ORP electrodes	32	✓	✓	✓			✓	✓	✓							
Analogue electrodes																
pH electrodes	65	✓	✓	✓	✓	✓	✓	✓	✓	✓	✓	✓	✓	✓	✓	
Special pH electrodes:	67	✓	✓	✓	✓	✓	✓	✓	✓	✓	✓	✓	✓	✓	✓	
ORP electrodes	73	✓	✓	✓	✓	✓	✓	✓	✓	✓	✓	✓	✓	✓	✓	
Ion-selective electrodes	81	✓	✓		✓					✓	✓	✓				
		Multi 9630	Multi 9620	Multi 9310	pH/ION 7320	pH 7310	pH 7110	Multi 3630	Multi 3620	Multi 3510	Multi 3320	pH/Cond 3320	pH/ION 3310	pH 3310	pH 3110	pHotoFlex® pH
see page		40	40	41	56	56	57	44	45	46	49	50	32	61	62	145

# Benchtop pH meters

The pH measurement benefits from the possibilities of IDS technology like no other measurement. With this, all requirements for Reliable measurements and GLP/AQA compliant documentation can be fulfilled in a simple and efficient manner.

## inoLab® IDS – digital



pH measurements with the new digital multi parameter benchtop meters inoLab® IDS:

### inoLab® Multi 9630 IDS: Measure three parameters simultaneously

The digital inoLab® multi parameter meter for IDS sensors for simultaneous measurement of the same or different parameters. Up to three sensors can be connected. Also suitable for analogue electrodes with an adapter.

see page 40



inoLab® Multi 9630 IDS

### inoLab® Multi 9620 IDS: Measure two parameters simultaneously

Two channel version of the inoLab® Multi 9630 IDS.

see page 40



inoLab® Multi 9620 IDS

### inoLab® Multi 9310 IDS: Digital single parameter solution

The new inoLab® Multi 9310 IDS is well suited for pH measurement in the laboratory. The IDS technology allows optimized measurements and efficient documentation in the simplest manner.

see page 41



inoLab® Multi 9310 IDS

# inoLab® - analogue

All benchtop meters are available in application-oriented sets including sensors and accessories.

**inoLab**  
innovations that make sense

3 year warranty IP 43 CE



inoLab® pH 7110 SET 4

## Technical specifications: inoLab® analogue benchtop pH meters

	inoLab® pH/ION 7320	inoLab® pH 7310	inoLab® pH 7110
<b>Measurement ranges/dissolution</b>	<b>pH</b>	-2.000 ... +20.000 pH	-2.0 ... 20.0 ±0.1 pH -2.00 ... 20.00 ±0.01 pH -2.000 ... 19.999 ±0.005 pH
	<b>mV</b>	±1200.0 mV ± 2500 mV	±1200.0 mV ± 2500 mV
	<b>Temp.</b>	-5 ... +105 °C/0.1 °C	-5.0 ... +105.0 °C ±0.1 °C
	<b>Conc.</b>	0.000 ... 9.999 (mg/l, µmol/l, 10.00 ... 99.99 mg/kg, ppm, 100.0 ... 999.9 %) 1000 ... 999999	
<b>Accuracy (±1 digit)</b>	<b>pH</b>	±0.005 pH ±0.01 pH	±0.005 pH ±0.01 pH
	<b>mV</b>	±0.3 mV, ±1 mV	±0.3 mV, ±1 mV
	<b>Temp.</b>	±0.1 K	±0.1 K
<b>Calibration</b>		1-, 2-, 3-, 4-, 5-point, WTW techn. buffer, DIN, NIST, as well as additional 20 buffer sets	1-, 2- or 3-point WTW technical buffers or DIN/NIST
	<b>MultiCal® calibration automatic:</b>		
	<b>AutoCal</b>	2-/3-/4-/5 point	
	<b>AutoCal-Tec</b>	2-/3-/4-/5 point	
	<b>ConCal®</b>	1-/2-/5 point	
	<b>ISECal</b>	2 bis 7 points	
	Special functions: Known addition (single) Known subtraction Sample addition Sample subtraction Known addition with blank value correction		

## inoLab® pH/ION 7320 - Reliable ISE measurement and documentation

The inoLab® pH/ION 7320 with two pH/mV/ISE inputs is perfectly suited for precision measurement and automatic GLP/AQA compliant documentation in quality laboratories of all industries. Also available with optional built in printer.



inoLab® pH/ION 7320P (with built-in printer)

see page 78



## inoLab® pH 7310: Reliable pH documentation



inoLab® pH 7310P (with built-in printer)

- **USB interface for fast data transfer**
- **Data output in \*.csv-Format or via optionally installed printer**
- **CMC function for measuring range monitoring**

The inoLab® pH 7310 is perfectly suited for precision measurement and automatic GLP/AQA compliant documentation in quality laboratories of all industries. Also available with optionally installed printer.

### Reliable measurements

- Repeatable measurement results due to active automatic AutoRead function for the detection of stable measured values
- The CMC function visualizes the optimal measuring range for correct measurement
- Graphic display with clear text menus for convenient and safe operation

### GLP/AQA compliant documentation

- Alphanumeric input of the electrode serial number
- Transfer of all data in \*.csv format via USB interface at the PC, formatted takeover into Excel (MultiLab® Importer)
- Output possible via optionally installed printer

### Flexible and high performance:

- 1- to 5-point calibration with calibration timer for all requirements
- 24 pre-programmed buffer sets for easy calibration
- 1- to 5-point calibration with customer-specific buffers
- Backlit graphics display



## inoLab® pH 7110: Accurate pH measurement



inoLab® pH 7110

- **Active AutoRead function**
- **Easy calibration with adjustable calibration timer**
- **Intuitive operation with well laid out keyboard**

The inoLab® pH 7110 is optimally suited for routine measurement in the laboratory, where automatic documentation has no priority. With a smooth, easy to clean surface.

### Reliable measurements

- Repeatable measurement results due to active automatic AutoRead function for the detection of stable measuring values
- Secure operation: Automated functions reduce the number of keys
- Increased measuring accuracy through adjustable calibration timer

### Easy and reliable:

- 1 to 3 point calibration with calibration timer
- MultiCal® Calibration system
- Automatic temperature compensation
- Large multi-function display for pH value and temperature

## Order information: Benchtop pH meters inoLab® analogue

Model	Description	Order no.
inoLab® pH 7310P	Convenient, menu-guided pH/mV benchtop meter (DIN) for measurements/GLP/AQA compliant documentation with built-in thermal printer. Single meter with universal power supply, stand, operating manual, CD-ROM with software, USB cable.	1AA310P
inoLab® pH 7310 SET 4	Convenient, menu-guided pH/mV benchtop meter (DIN) for measurements/GLP/AQA compliant documentation. Meter with universal power supply, stand and operating instructions, pH electrode SenTix® 81, buffer 4,7 and 10.01, 3 mol/l KCl, CD-ROM with software, USB cable.	1AA314
inoLab® pH 7110 SET 2	Simple, easy-to-use pH/mV benchtop meter (DIN) for routine measurements. Meter with universal power supply, stand and operating instructions, pH electrode SenTix® 41, buffer 4, 7 and 10.01, 3 mol/l KCl.	1AA112

Further sensors and electrodes in the SET or BNC versions see price list or [www.WTW.com](http://www.WTW.com)

## Portable pH meters

pH value is a parameter, which also plays an important role with on-site measurements. The spectrum ranges from measuring pH in surface water up to the measurement in the process of a chemical plant.

### MultiLine® IDS - digital



pH measurements with the new digital MultiLine® multi-parameter measuring instruments:

#### Multi 3630 IDS: Measure three parameters simultaneously

Three galvanically isolated measurement channels, can be freely combined for the same or different parameters. Simultaneous multi measurement without compromises.



MultiLine® Multi 3630 IDS

see page 44

#### Multi 3620 IDS: Measure two parameters simultaneously

Two galvanically isolated measurement channels, can be used simultaneously for identical or different parameters. Economic multi-parameter meter for many applications in which two parameters must be measured and/or stored simultaneously.



MultiLine® Multi 3620 IDS

see page 45

#### MultiLine® Multi 3510 IDS: Digital single parameter solution

The single-channel multi-parameter instrument Multi 3510 IDS is ideal for portable pH measurement in all conditions both outdoors and in a plant. Like all MultiLine® IDS meters, it is also suitable for pH measurement with cable lengths of up to 100 m.



MultiLine® Multi 3510 IDS

see page 46

### pHotoFlex® Series

Successful combination of photometer and optional turbidity measurement in combination with a built-in pH / mV meter.

see "pHotoFlex® pH - Portable photometer with pH measurement function" on page 145



pHotoFlex® pH

# ProfiLine - analogue

All portable meters are available including sensors and accessories in a practical field case.



ProfiLine pH 3310 SET 2

## Technical specifications: Profiline portable analogue pH meters

ProfiLine		Multi 3320	pH/Cond 3320	pH/ION 3310	pH 3310	pH 3110
<b>Measurement ranges/resolution</b>	<b>pH</b>	-2.0 ... 20.0 -2.00 ... 20.00 -2.000 ... 19.999	-2.0 ... 20.0 -2.00 ... 20.00 -2.000 ... 19.999	-2.0 ... 20.0 -2.00 ... 20.00 -2.000 ... 19.999	-2.0 ... 20.0 -2.00 ... 20.00 -2.000 ... 19.999	-2.0 ... 20.0 -2.00 ... 20.00 -2.000 ... 19.999
	<b>mV</b>	± 1200.0 ± 2500	± 1200.0 ± 2500	± 1200.0 ± 2500	± 1200.0 ± 2500	± 1200.0 ± 2000
	<b>Temp.</b>	-5.0 ... +105.0 °C	-5.0 ... +105.0 °C	-5.0 ... +105.0 °C	-5.0 ... +105.0 °C	-5.0 ... +105.0 °C
	<b>Conc.</b>	0.000 ... 9.999 (mg/l, µmol/l, mg/kg, ppm, %) 100.0 ... 999.9 1000 ... 999999	0.000 ... 9.999 10.00 ... 99.99 100.0 ... 999.9 1000 ... 999999	0.000 ... 9.999 10.00 ... 99.99 100.0 ... 999.9 1000 ... 999999	-	-
<b>Accuracy (±1 digit)</b>	<b>pH</b>	± 0.1 pH ± 0.01 pH ± 0.005 pH	± 0.1 pH ± 0.01 pH ± 0.005 pH	± 0.1 pH ± 0.01 pH ± 0.005 pH	± 0.1 pH ± 0.01 pH ± 0.005 pH	± 0.1 pH ± 0.01 pH ± 0.005 pH
	<b>mV</b>	± 0.3 mV ± 1 mV	± 0.3 mV ± 1 mV	± 0.3 mV ± 1 mV	± 0.3 mV ± 1 mV	± 0.3 mV ± 1 mV
	<b>Temp.</b>	± 0.1 °C	± 0.1 °C	± 0.1 °C	± 0.1 °C	± 0.1 °C
<b>Calibration</b>		1-, 2-, 3-, 4-, 5-point, WTW techn., DIN, NIST as well as additional 22 buffer sets, 1- to 5-point ConCal® calibration with arbitrary buffers				1-, 2-, 3-point, WTW techn. and DIN buffers
	<b>ISE</b>	2-7 points	2-7 points	2-7 points	-	-
<b>CMC</b>		Yes	Yes	Yes	Yes	-
<b>Data memory</b>		Manual 200/5000 automatic	Manual 200/5000 automatic	Manual 200/5000 automatic	Manual 200/5000 automatic	-
<b>Logger</b>		Manually/time-controlled	Manually/time-controlled	Manually/time-controlled	Manually/time-controlled	-
<b>Display</b>		LCD graphics, backlit	LCD graphics, backlit	LCD graphics, backlit	LCD graphics, backlit	7-Segment LCD
<b>Standby operation</b>		Up to 800 h without/ 100 h with illumination	Up to 800 h without/ 100 h with illumination	Up to 800 h without/ 100 h with illumination	Up to 800 h without/ 100 h with illumination	Up to 2500 h

Неварреактив

## ProfiLine Multi 3320: The environment specialist

The Multi 3320 for the measurement of pH, ISE, ORP, conductivity and dissolved oxygen (electrochemical) is an ideal meter for environmental applications in the area of ground and surface water measurement, aquaculture, as well as in a wastewater treatment plant and much more.

see page 49



ProfiLine Multi 3320

## ProfiLine pH/Cond 3320: Perfect in process

The pH / Cond 3320 with two inputs for pH, mV, ISE and conductivity measurement is an all-rounder for almost all applications in process chemistry from life science, food and beverage to the pharmaceutical industry (measurement of pH and conductivity according to pharmacopoeia).

see page 50



ProfiLine pH/Cond 3320

## ProfiLine pH/ION 3310: pH-, mV- and concentration measurement in one hand

pH/ISE portable meter for pH, mV and concentration measurement - suitable for all areas where accuracy and high-quality results are important.

see page 80



ProfiLine pH/ION 3310



Неварреактив

## ProfiLine pH 3310: Reliable pH documentation



ProfiLine pH 3310

- **Waterproof USB interface for fast data transfer**
- **Data output in \*.csv-Format**
- **Data logger for up to 5000 data sets**

The pH 3310 is an elegant combination of a robust portable meter and data logger for anyone who wants to automatically save measurement series and process them further on the PC.

### Reliable measurements

- Repeatable measurement results due to active automatic AutoRead function
- The CMC function visualises the optimal measuring range and supports correct measuring
- Graphic display with plain text menus for convenient and safe operation

### GLP/AQA compliant documentation

- Transmission of all data in \*.csv format via USB interface at the PC
- Formatted takeover into Excel (MultiLab® Importer included in the delivery or as a download)

### Flexible and high performance:

- 1- to 5-point calibration with calibration timer for all measuring tasks
- 24 pre-programmed buffer sets for easy calibration
- Backlit graphic display with CMC display



## ProfiLine pH 3110: Easy pH measurement



ProfiLine pH 3110

- pH or ORP measurement
- Simple 1 to 3 point calibration with adjustable calibration timer
- Robust and waterproof (IP 67)

The pH 3110 is ideal for anyone looking for a simple, robust and waterproof meter for portable pH measurement.

### Reliable measurements

- Repeatable measurement results due to active automatic AutoRead function for the detection of stable measured values
- For the safe operation automated functions and simplified keyboard
- A waterproof DIN socket enables for measurement also in a humid environment

### Easy and reliable:

- Easily readable display for measured value and temperature
- Silicon keyboard with tactile key click, operable with gloves
- For field use in a carrying case set with proven electrodes

## Order information: ProfiLine portable measuring pH meters

Model	Description	Order no.
ProfiLine pH 3310 SET 2	Robust and waterproof portable pH meter with data logger and USB Mini-B interface, for battery operation, in a carrying case kit with SenTix® 41	2AA312
ProfiLine pH 3110 SET 2	Robust and waterproof portable pH meter for battery operation, in a carrying case kit with SenTix® 41	2AA112

Further electrodes in SET see price list or [www.WTW.com](http://www.WTW.com)

# pH electrodes

## IDS electrodes - digital



Digital measurement of pH with integrated electrode quality monitoring - can be used in all areas of laboratory and field measurement also for special applications. Also as fixed cable variants and wireless ready.

see "IDS pH electrodes" on page 28



from left to right: the digital IDS sensors (1) SenTix® 940, (2) SenTix® 945, (3) SenTix® 950, (4) SenTix® 980; the IDS special electrodes (5) SenTix® HW-T 900, (6) SenTix® Sp-T 900, (7) SenTix® Micro 900; the wireless ready IDS plug head electrodes (8) SenTix® 940-P, (9) SenTix® 945-P, (10) SenTix® 950-P, (11) SenTix® Sp-T 900-P, (12) SenTix® 980-P, (13) SenTix® HW-T 900-P, (14) SenTix® Micro 900-P and (15) SensoLyt® 900-P



## Applications for SenTix® electrodes

Our pH electrodes are optimised for measurement in aqueous systems. In addition, there is the possibility also measure samples of a different consistence. The following table provides information about other application fields and electrodes suitable therefor.

- recommended by WTW
- can be used for this application

\* only recommended for the mentioned model

	SenTix® ...											
	20 21-..., 22	41, 41-3, 42, RJD, 940, 940-P	51, 52, 950, 950-P	60, 61 62	81, 82, 980, 980-P, 945, 945-P	91	H	HW, HWD, HW-T 900, HW-T 900-P	Sp, Sp-DIN, Sp-T 900, Sp-T 900-P	Sur	Mic, MIC-D, MIC-B, Micro 900, Micro 900-P	ORP**, ORPT 900**, ORPT 900-P**, PtR, Ag, Au
Aquarium water	●	●	●	○	○	○						ORP..*, PtR*
Beer			●	●	●			●				ORP..*
Beverages				●	●	●		○				
Bleaching lye			○	○	○	○	●	○				
Boiler feed water				○	○	○		●				
Bread									●			
Cheese (punch possibly necessary)									●			
Coffee extract			○	●	●	●		●				
Condensate								●				
Cosmetics								●	●	●		
Diluted acids				●	●	●		○				Au, ORP..*
Diluted alkalis							●					
Dispersion colors		RJD*						●				
Distilled water								●				
Drinking water	○	○	●	●	●	●		○				
Electroplating waster water	●	●	○	○	○	○		○				○
Fruit									●			
Fruit juice			●	●	●	●		○				
Fruit juice			●	●	●	●		○				
Fully demineralised water								●				
Galvanic baths		RJD*	●	●	●	●		○				●
Groundwater	●	●	○	○	○							PtR*
H <sub>2</sub> S-containing liquids		RJD*						●				PtR*
Household cleaners	○	○	○	●	●	●	●	○				
Leather										●		
Lemonade			●	●	●	●		○				
Measurement in Eppendorf or NMR vessels											●	
Meat (punch possibly necessary)									●			
Milk				●	●	●		●				
Mineral water	○	○	●	●	●	●		○				
Oil/water emulsions		RJD*						●				
Paints and coatings, water soluble		RJD*						●				
Paper										●		
Paper extract				●	●	●						
Protein-containing liquids				●	●	●		●			MIC-D/-B* Micro 900*	
Rain water				○	○	○		●				
saline solutions	○	○	○	●	●	●	○	●				ORP..*
saliva										●	○	
Sausage (punch possibly necessary)									●			
Seawater				○	○	○	○	●				
Shampoo								●				
Skin										●		
Soil extract				●	●	●		●				
Solids (insertion)									●			
Solids (surface)										●		
Surface water	●	●	●	●	●	●		○				
Suspensions		RJD*						●				ORP..*
Swimming pool water	●	●	●	○	○	○						
Tris buffer solutions				●	●	●		●				
Vegetable juice			○	●	●	●		○				
Vegetables									●			
Waste water	●	●	○	○	○	○						PtR*
Wine			○	●	●	●		●				
Yoghurt				●	●	●		●	●			

1 year warranty for material damages for all pH sensors as per § 10 Terms and Conditions  
\*\* for ORP measurement

# SenTix® pH electrodes analogue

WTW SenTix® quality electrodes – measurement convenience and precision in one.

- Low-resistance membrane glasses warranty stable measurement signals even at low temperatures
- Silver ion-free reference electrolyte together with the proven platinum wire junction prevents measurement problems due to precipitating silver compounds
- Functional slider for opening and safe closing of the refill opening with electrodes with liquid electrolyte.
- Connection possibilities: waterproof DIN plug, BNC plug, fixed cable (1 or 3 m) or plug head (S7)

## Technical specifications: SenTix® pH electrodes analogue

Models SenTix® ...	pH electrodes with gel electrolyte							pH electrodes with liquid electrolyte							
	20	21	21-3	22	41	41-3	42	51	52	60	61	62	81	82	91
Measurement Range pH	0 ... 14 pH			0 ... 14 pH				0 ... 14 pH		0 ... 14 pH			0 ... 14 pH		0 ... 14 pH
Application area temp.	0 ... 80 °C			0 ... 80 °C				0 ... 80 °C		0 ... 100 °C			0 ... 100 °C		0 ... 100 °C
Reference electrolyte	Gel							KCl 3 mol/l, Ag <sup>+</sup> -free							
Membrane shape	Cylinder			Cylinder				Cylinder		Cone			Cone		sphere
Membrane resistance	< 1 GΩ			< 1 GΩ				< 1 GΩ		< 600 MΩ			< 600 MΩ		< 600 MΩ
Diaphragm	Fibre			Fibre				Ceramics		Platinum			Platinum		Platinum
Shaft material	Plastic			Plastic				Plastic		Glass			Glass		Glass
Shaft length (±2 mm)	120 mm			120 mm				120 mm		120 mm			120 mm		170 mm
Shaft-Ø (±0.5 mm)	12 mm			12 mm				12 mm		12 mm			12 mm		12 mm
Temperature sensor	-			integr. NTC (30 KΩ)				integr. NTC (30 KΩ)		-			integr. NTC (30 KΩ)		integr. NTC (30 KΩ)
Connection	①	②	②	②	②	②	②	②	②	①	②	②	②	②	②
Electrode cable	③*	④	⑤	④	④	⑤	④	④	④	③*	④	④	④	④	④
Electrode plug	⑥/⑦	⑥	⑥	⑦	⑥+⑧	⑥+⑧	⑦+⑧	⑥+⑧	⑦+⑧	⑥/⑦	⑥	⑦	⑥+⑧	⑦+⑧	⑥+⑧

Models SenTix® ...	pH electrodes for special applications									
	H	HW	HWD	SP	SP-DIN	Sur	Mic	Mic-D	Mic-B	RJD
Measurement Range pH	0 ... 14 pH	0 ... 14 pH	0 ... 14 pH	2 ... 13 pH	2 ... 13 pH	2 ... 13 pH	0 ... 14 pH	0 ... 14 pH	2 ... 13 pH	2 ... 13 pH
Application area temp.	0 ... 80 °C	0 ... 60 °C	-5 ... 100 °C	0 ... 80 °C	0 ... 80 °C	0 ... 50 °C	0 ... 100 °C	-5 ... 100 °C	0 ... 80 °C	0 ... 80 °C
Reference electrolyte	KCl 3 mol/l, Ag <sup>+</sup> -free			Polymer			KCl 3 mol/l, Ag <sup>+</sup> -free		Polymer	
Membrane shape	Cylinder	Cylinder	Sphere	Spear	Flat	Cylinder	Cylinder	Calotte	Calotte	Calotte
Membrane resistance	< 2 GΩ	< 800 MΩ	< 600 MΩ	< 400 MΩ	< 1 GΩ	< 700 MΩ	< 1 GΩ	< 600 MΩ	< 600 MΩ	< 600 MΩ
Diaphragm	Split ring	Split ring	Split ring	Hole	Split ring	Ceramics	Platinum	Split ring	Split ring	Split ring
Shaft material	Glass	Glass	Glass		Glass	Glass	Glass	Glass	Glass	Glass
Shaft length (±2 mm)	170 mm	170 mm	170 mm	65/25 mm	120 mm	40/80 mm	96 mm **	120 mm	120 mm	120 mm
Shaft-Ø (±0.5 mm)	12 mm	12 mm	12 mm	15/5 mm	12 mm	12/5 mm	3 mm	12 mm	12 mm	12 mm
Temperature sensor	-	-	integr. NTC (30 KΩ)	-	-	-	-	-	integr. NTC (30 KΩ)	integr. NTC (30 KΩ)
Connection	①	①	②	①	②	①	①	②	②	②
Electrode cable	③*	③*	④	③*	④	③*	③*	④	④	④
Electrode plug	⑥/⑦	⑥/⑦	⑥+⑧	⑥/⑦	⑥	⑥/⑦	⑥/⑦	⑥	⑦	⑥+⑧

\* not included in the scope of delivery  
 \*\* from grinding paper edge  
 ①: Plug head, ②: Fixed cable,  
 ③: AS/DIN, AS/DIN-3 or AS/BNC, ④: Cable length 1 m, ⑤: Cable length 3 m,  
 ⑥: DIN plug, ⑦: BNC plug, ⑧: Banana plug

## Low maintenance analogue pH electrodes with gel electrolyte

Ideal for portable measurement but also for routine measurement in the laboratory. With or without built-in temperature sensor All electrodes have robust plastic shafts and a low-maintenance gel reference system.



SenTix® 20



SenTix® 21



SenTix® 41



## Quick and precise analogue pH electrodes with liquid electrolyte

For demanding measurements in the laboratory: SenTix® Electrodes with liquid electrolyte, easy to clean glass shaft and platinum diaphragm. Can also be used in difficult samples. And who needs an electrode with liquid electrolyte for portable measurement: The SenTix® 51/52 with plastic shaft, integrated temperature sensor and ceramic diaphragm masters nearly every measuring task.



SenTix® 51/52



SenTix® 60



SenTix® 61



SenTix® 81



SenTix® 91

## Analogue pH electrodes for special applications: Specialists for all cases

The consistencies of samples in which pH is measured are very different. Liquid or solid, low in ions or highly concentrated, aqueous and non-aqueous phases, with and without suspended solids. Sometimes the smallest volumes have to be determined. All this can be handled easily together with our specialists.

For measurements in or on solids, spear-type and surface electrodes are recommended. pH value measurements in ion-poor or concentrated solutions can be mastered with ground electrodes, as well as in emulsions. Samples with suspended solids can most easily be measured with polymer electrodes. Micro-electrodes help when there is little volume available.

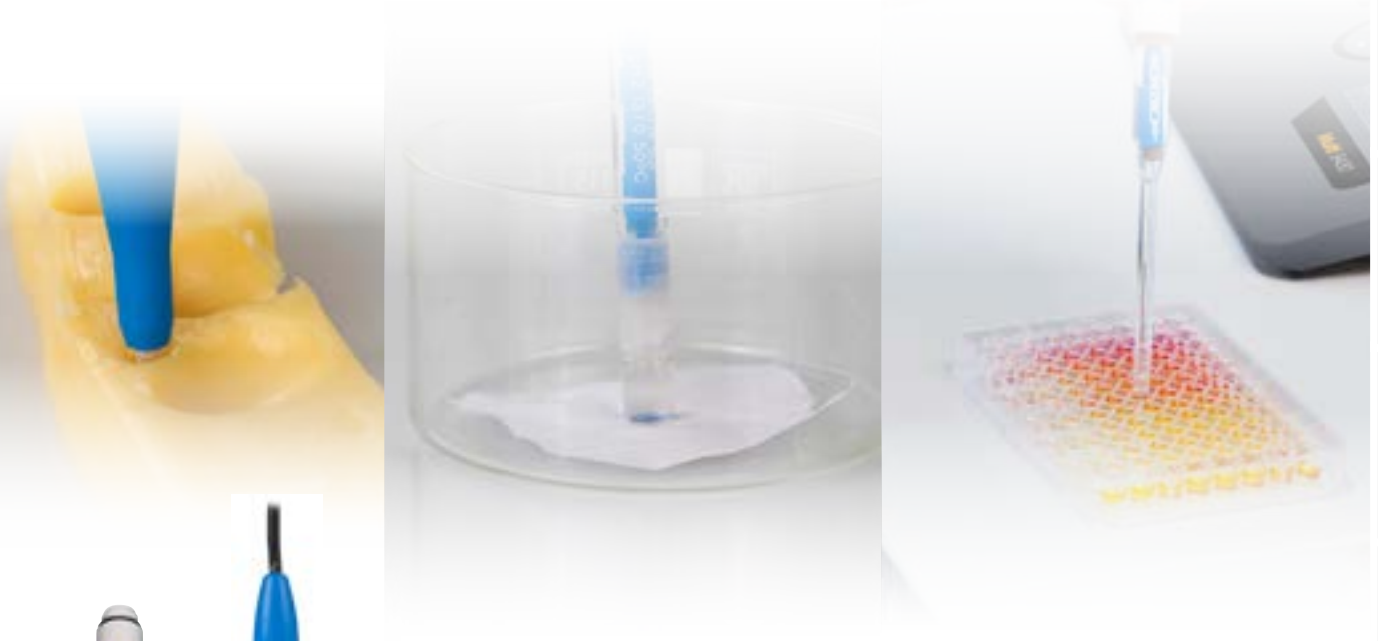

SenTix® HWD



SenTix® HWD



SenTix® SP



SenTix® Sur



SenTix® Mic



SenTix® Mic-D



SenTix® RJD

## Order information: Analogue SenTix® pH electrodes

Model	Description	Order no.
<b>pH electrodes with gel electrolyte</b>		
SenTix® 20	Gel electrode, S7 plug head	103630
SenTix® 21	Gel electrode, DIN cable	103631
SenTix® 21-3	Gel electrode, DIN cable, 3 m	103632
SenTix® 22	Gel electrode, BNC cable	103633
SenTix® 41	Gel electrode with temperature sensor, DIN cable	103635
SenTix® 41-3	Gel electrode with temperature sensor, DIN cable, 3 m	103636
SenTix® 42	Gel electrode with temperature sensor, BNC cable	103637
<b>pH electrodes with liquid electrolyte</b>		
SenTix® 60	Precision electrode, S7 plug head	103639
SenTix® 61	Precision electrode, DIN cable	103640
SenTix® 62	Precision electrode, BNC cable	103641
SenTix® 81	Precision electrode with temperature sensor, DIN cable	103642
SenTix® 82	Precision electrode with temperature sensor, BNC cable	103643
SenTix® 51	Plastic shaft, temperature sensor, DIN cable	103651
SenTix® 52	Plastic shaft, temperature sensor, BNC cable	103652
SenTix® 91	Precision electrode 170 mm, with temperature sensor, DIN cable	103695
<b>pH electrodes for special applications</b>		
SenTix® H	pH electrode for highly alkaline solutions, S7 plug head	103644
SenTix® Sp	pH spear-type electrode, S7 plug head	103645
SenTix® Sur	pH surface electrode, S7 plug head	103646
SenTix® Mic	pH-micro electrode, 5 mm membrane	103647
SenTix® HW	pH electrode for low-conducting samples, S7 plug head	103650
SenTix® Mic-D	pH micro electrode, 3 mm membrane, DIN cable	103660
SenTix® Mic-B	pH micro electrode, 3 mm membrane, BNC cable	103661
SenTix® Sp-DIN	pH spear-type electrode, DIN cable	103730
SenTix® HWD	pH electrode for emulsions etc. with temperature sensor, DIN cable	103731
SenTix® RJD	pH electrode low maintenance, polymer electrolyte, temperature sensor, DIN cable	103732

Accessories & cables see price list or [www.WTW.com](http://www.WTW.com)

## Calibration and maintenance accessories

In practice, work reference buffer solutions are used, which are obtained by comparison with primary or secondary material. Common WTW-pH buffers correspond to these requirements. Certificates document the respective pH value uncertainty of the solution.

### Buffer bottles by WTW

- **Standard (DIN/NIST) buffer solutions PL 2/4/7/9/12** (250 ml container)
- Technical buffer solutions **TEP** (1 litre), **TPL** (250 ml):  
pH buffer by WTW - precise and traceable to PTB/NIST in two container sizes with built-in dosing vessel standard



- **Easy to dose**
- **Easy to use**
- **Safe calibration**

## Usable Buffers

		PL 4/7/9 DIN/NIST	STAPL 4/7/9 DIN/NIST	TEP 4/7 Trace	TEP 10 Trace	TPL 4/7 Trace	TPL 10 Trace
<b>Benchtop meters</b>							
<b>inoLab®</b>		●	●	●	●	●	●
<b>Portable meters</b>							
<b>ProfiLine</b>	<b>pH 3110, pH 3210, pH 3310</b>	●	●	●	●	●	●
	<b>pH/Cond 3320, Multi 3320, pH/ION 3310</b>	●*	●*	●	●	●	●
	<b>pH 315i, pH 330i, pH 340i, pH/ION 340i</b>	●	●	●	●	●	●
	<b>pH/Cond 340i, pH/Oxi 340i, Multi 340i, Multi 350i,</b>	●*	●*	●	●	●	●
<b>MultiLine®</b>	<b>Multi 3410 IDS, Multi 3420 IDS, Multi 3430 IDS, Multi 3510 IDS, Multi 3620 IDS, Multi 3630 IDS</b>	●*	●*	●	●	●	●
<b>VARIO® pH</b>		●	●	●	●	●	●
<b>Field meters ProfiLine</b>							
	<b>pH 197i/1970i</b>	●	●	●	●	●	●
	<b>Multi 197i/1970i</b>	●*	●*	●	●	●	●

\* not Multi 340i, Multi 197i/1970i

## Buffer solutions in glass ampoules

- **STAPL-4/7/9 precision DIN / NIST buffer in ampoules with +/- 0.01 pH accuracy**
- QSC (Quality Sensor Control): With the **QSC Kit** consisting of three precision DIN buffers (pH 4.01, pH 6.87 and pH 9.18 with an accuracy of respectively  $\pm 0.01$  pH at 25°C) in glass ampoules, an initial calibration can be carried out with IDS pH electrodes. Ideal for quality control: All following calibrations are compared with this calibration and thereby exactly deliver the current state of the sensor.



- **Single use portions**
- **Steam sterilised and 5 year shelf life**
- **Precision buffer with an accuracy of  $\pm 0.01$  pH**

Model	Description	Order no.
<b>TEP 4</b>	Technical buffer solution, 1 bottle with 1 l: pH 4.01	108700
<b>TEP 7</b>	Technical buffer solution, 1 bottle with 1 l: pH 7.00	108702
<b>TEP 10 Trace</b>	Technical buffer solution, 1 bottle with 1 l: pH 10.01	108703
<b>TPL 4</b>	Technical buffer solution, 1 bottle with 250 ml: pH 4.01	108800
<b>TPL 7</b>	Technical buffer solution, 1 bottle with 250 ml: pH 7.00	108802
<b>TPL 10 Trace</b>	Technical buffer solution, 1 bottle with 250 ml: pH 10.01	108805
<b>STAPL-4/7/9</b>	Assortment of working reference buffer solutions pH 4.01, pH 6.87, pH 9.18. Traceable to NIST / PTB standards. Steam sterilized, 10 x 6 glass ampoules of 20 ml each.	109020
<b>PL 4</b>	Standard (DIN/NIST) buffer solution, 1 bottle with 250 ml: pH 4.006 /4.01	109110
<b>PL 7</b>	Standard (DIN/NIST) buffer solution, 1 bottle with 250 ml: pH 6.865 /6.87	109120
<b>PL 9</b>	Standard (DIN/NIST) buffer solution, 1 bottle with 250 ml: pH 9.180 /9.18	109130
<b>K</b>	Reference electrolyte, 1 bottle with 250 ml KCl solution 3 mol/l	109705

Further accessories see price list or [www.WTW.com](http://www.WTW.com)

# ORP measurement



---

## Content

71 Applications and meters overview

72 ORP electrodes

72 IDS ORP Electrodes - digital

73 SenTix® ORP Electrodes - analogue

# Applications and meters overview

The ORP measurement maps the intensity of oxidation and reduction reactions proceeding in aqueous solution. The resulting voltage signal is for example used as a measure of the cleaning power of disinfectants such as chlorine or ozone in the swimming pool.

	Digital			Analogue			Digital			Analogue						
	Laboratory ORP meters						Portable ORP meters									
	inoLab® IDS			inoLab®			MultiLine® IDS			ProfiLine						
	Multi 9630	Multi 9620	Multi 9310	pH/ION 7320	pH 7310	pH 7110	Multi 3630	Multi 3620	Multi 3510	Multi 3320	pH/Cond 3320	pH/ION 3310	pH 3310	pH 3110	pHotoFlex® pH	
✓ yes																
● yes																
✓ recommended																
✓ recommended for some applications																
– not recommended																
2 parameters simultaneously*	✓	✓		✓			✓	✓		✓	✓					
3 parameters simultaneously	✓						✓									
ORP	●	●	●	●	●	●	●	●	●	●	●	●	●	●	●	
Additional parameters	●	●	●	●			●	●	●	●	●				●*	
Routine measurements	✓	✓	✓	✓	✓	✓	✓	✓	✓	✓	✓	✓	✓	✓	✓	
Routine measurements with documentation	✓	✓	✓	✓	✓	–	✓	✓	✓	✓	✓	✓	✓	–	✓	
AQA with documentation	✓	✓	✓	✓	✓	–	✓	✓	✓	✓	✓	✓	✓	–	✓	
R&D High resolution and precision	✓	✓	✓	✓	✓	–	✓	✓	✓	✓	✓	✓	✓	–	✓	
Control measurements	✓	✓	✓	✓	✓	–	✓	✓	✓	✓	✓	✓	✓	–	✓	
LIMS connection	✓	✓	✓	✓	✓	–	✓	✓	✓	✓	✓	✓	✓	–	✓	
Quality assurance	✓	✓	✓	✓	✓	–	✓	✓	✓	✓	✓	✓	✓	–	✓	
Education	✓	✓	✓	✓	✓	✓	✓	✓	✓	✓	✓	✓	✓	✓	✓	
Service	–	–	–	–	–	–	✓	✓	✓	✓	✓	✓	✓	✓	✓	
Laboratory measurements	✓	✓	✓	✓	✓	✓	✓	✓	✓	✓	✓	✓	✓	✓	✓	
Field measurements	–	–	–	–	–	–	✓	✓	✓	✓	✓	✓	✓	✓	✓	
Depth measurements	–	–	–	–	–	–	✓	✓	✓	–	–	–	–	–	–	
PC connection	✓	✓	✓	✓	✓		✓	✓	✓	✓	✓	✓	✓		✓	
Memory	✓	✓	✓	✓	✓		✓	✓	✓	✓	✓	✓	✓			
USB interface	✓	✓	✓	✓	✓		✓	✓	✓	✓	✓	✓	✓			
Graphic display			✓	✓	✓				✓	✓	✓	✓	✓		✓	
Color graphic display	✓	✓					✓	✓								
Compatible sensors																
Digital IDS electrodes																
IDS ORP electrodes	72	✓	✓	✓			✓	✓	✓							
Analogue electrodes																
ORP electrodes	73	✓	✓	✓	✓	✓	✓	✓	✓	✓	✓	✓	✓	✓	✓	
		Multi 9630	Multi 9620	Multi 9310	pH/ION 7320	pH 7310	pH 7110	Multi 3630	Multi 3620	Multi 3510	Multi 3320	pH/Cond 3320	pH/ION 3310	pH 3310	pH 3110	pHotoFlex® pH

see page 40 40 41 56 56 57 44 45 46 49 50 47 61 62 145

see chapter "Photometric determination" on page 130

ORP measurements can be carried out with all WTW pH/mV meters.



# ORP electrodes

All ORP electrodes consist of a metal electrode made of a precious metal and a reference electrode. As with all SenTix® and SensoLyt® electrodes, the reference system is silver/silver chloride, typically with a platinum electrode.

WTW meters with pH function also measure the ORP voltage

## IDS ORP electrodes - digital



- Short response time due to ideal contact to the sample
- Precise measurement results due to liquid electrolyte
- Refillable for a long life
- Platinum electrode for universal application

### SenTix® ORP-T900 (-P)

ORP electrodes with liquid electrolyte and ceramic diaphragm



- No maintenance due to life-long KCl supply
- Insensitive to soiling due to open connection
- Wide application range due to universal platinum metal electrode

### SensoLyt® ORP 900-P

ORP electrodes with polymer electrolyte and split ring or hole junction

Technical data and order information:

see page 32

# SenTix® ORP electrodes - analogue

Technical data and order information: SenTix® ORP electrodes - analogue

	SenTix® ORP	SenTix® Ag*	SenTix® Au	SenTix® PtR
<b>Order no.</b>	103648	103664	103665	103666
<b>working temperature °C</b>	0 ... 100 °C	-5 ... 100 °C	-5 ... 100 °C	-5 ... 100 °C
<b>Reference electrolyte</b>	KCl 3 mol/l	ELY/ORP/Ag	KCl 3 mol/l	Gel
<b>Sensor</b>	Platinum	Silver	Gold	Platinum
<b>Sensor form</b>	(4 mm)	Cylinder cap	Cylinder cap	(6 mm)
<b>Diaphragm</b>	Ceramics	Ceramics	Ceramics	Split ring
<b>Shaft material</b>	Glass	Glass	Glass	Glass
<b>Shaft length (±2 mm)</b>	120 mm	120 mm	120 mm	120 mm
<b>Shaft-Ø (±0,5 mm)</b>	12 mm	12 mm	12 mm	12 mm
<b>Temperature sensor</b>	-	-	-	-
<b>Connection</b>	AS/DIN, AS/DIN-3, AS/BNC	AS/DIN, AS/DIN-3, AS/BNC	AS/DIN, AS/DIN-3, AS/BNC	AS/DIN, AS/DIN-3, AS/BNC

\* for argentometry



## SenTix® ORP

Universal ORP electrode with platinum round, glass shaft



## SenTix® Ag

Combined Ag electrode (argentometry)



## SenTix® Au

Au ORP electrode with AU cap, liquid electrolyte



## SenTix® PtR

Maintenance-free Pt ORP electrode with polymer electrolyte

Order information: Test and maintenance agents for the ORP measurement

Model	Description	Order no.
28	ORP buffer solution, 1 bottle with 250 ml: pH 7, U <sub>H</sub> = 427 mV	109740
ELV-AG	Electrolyte with 2 mol/l KNO <sub>3</sub> + 0.001 mol/l KCl for combined ORP electrode with silver electrode	109735
Accessories	cables see price list or www.WTW.com	

# Ion-selective measurement



---

## Content

- 75 *Applications and meters overview*
- 76 *Benchtop meters for ion-selective measurement*
  - 76 *inoLab® Multi IDS - digital*
  - 77 *inoLab® pH/ION - analogue*
- 79 *Portable meters for ion-selective measurement*
- 81 *Ion-selective electrodes*

# Applications and meters overview

Ion-selective measurement is an electrochemical process in which the concentration of a multitude of dissolved ions in liquids can be quantitatively determined with suitable electrodes.

- ✓ yes
- yes
- ✓ recommended
- ✓ recommended for some applications
- not recommended

	Digital		Analogue		Analogue	
	Benchtop ISE meters		Benchtop ISE meters		Portable ISE meters	
	inoLab® IDS		inoLab®		ProfiLine	
	Multi 9630	Multi 9620	pH/ION 7320	Multi 3320	pH/Cond 3320	pH/ION 3310
2 parameters simultaneously*	✓	✓	✓	✓	✓	✓
3 parameters simultaneously	✓					
ISE direct measurement	●	●	●	●	●	●
Incremental methods	●	●	●			
Additional parameters	●	●	●	●	●	●
Routine measurements	✓	✓	✓	✓	✓	✓
Routine measurements with documentation	✓	✓	✓	✓	✓	✓
AQA with documentation	✓	✓	✓	✓	✓	✓
R&D High resolution and precision	✓	✓	✓	✓	✓	✓
Control measurements	✓	✓	✓	✓	✓	✓
LIMS connection	✓	✓	✓	✓	✓	✓
Quality assurance	✓	✓	✓	✓	✓	✓
Education	✓	✓	✓	✓	✓	✓
Service	–	–	–	✓	✓	✓
Laboratory measurements	✓	✓	✓	✓	✓	✓
Field measurements	–	–	–	✓	✓	✓
PC connection	✓	✓	✓	✓	✓	✓
Memory	✓	✓	✓	✓	✓	✓
USB interface	✓	✓	✓	✓	✓	✓
Analogue/Digital adapter necessary	✓	✓				
Graphic display			✓	✓	✓	✓
Color graphic display	✓	✓				
	Compatible sensors					
	Analogue electrodes					
Combined ISE	82	✓	✓	✓	✓	✓
Half cells	83	✓	✓	✓		✓
	Multi 9630	Multi 9620	pH/ION 7320	Multi 3320	pH/Cond 3320	pH/ION 3310
	see page 40	see page 40	see page 56	see page 49	see page 50	see page 80

# Benchtop meters for ion-selective measurement

Ion-selective measurement can be performed in two general ways:

Simple, direct potentiometric determination via a linear or non-linear calibration curve, or determination via the so-called increment methods.

All state-of-the-art WTW laboratory meters with ISE function have both functionalities.

## inoLab® IDS - digital



### inoLab® Multi 9630 IDS: Measure three parameters simultaneously

The digital inoLab® multi parameter meter for IDS sensors for parallel measurement of the same or different parameters. Requires the ADA 94pH/IDS DIN or ADA 94pH/IDS BNC for the ISE measurement.



see page 40

inoLab® Multi 9630 IDS

### inoLab® Multi 9620 IDS: Measure two parameters simultaneously

Similar to inoLab® Multi 9630 IDS, but up to two sensors can be connected. Requires the ADA 94pH/IDS DIN or ADA 94pH/IDS BNC for the ISE measurement.



see page 40

inoLab® Multi 9620 IDS

# inoLab® - analogue

НеваРеактив



inoLab® pH/ION 7320P

**inoLab**  
innovations that make sense

3 year warranty IP 43 CE

## Technical specifications: inoLab® analogue benchtop ion selective meters

inoLab® pH/ION 7320	
<b>Measurement ranges/resolution</b>	<b>pH</b> -2.000 ... +20.000 pH units
	<b>mV</b> -1200 ... +1200 mV -2500 ... +2500 mV
	<b>Temperature</b> -5 ... +105 °C/0,1 °C
<b>Concentration</b>	0.000 ... 9.999
	(mg/l, µmol/l, 10.00 ... 99.99
	mg/kg, ppm, %) 100.0 ... 999.9
	1000 ... 999999
<b>Special functions</b>	Known addition (single), known subtraction, sample addition, sample subtraction, blank value correction
<b>Accuracy (±1 digit)</b>	<b>pH</b> ±0.005 pH units -±0.01 pH units
	<b>mV</b> ±0.3 mV, ±1 mV
	<b>Temperature</b> ±0.1 K
<b>Calibration MultiCal® calibration automatic:</b>	<b>AutoCal</b> 2-/3-/4-/5 point
	<b>AutoCal-Tec</b> 2-/3-/4-/5 point
	<b>ConCal®</b> 2-/3-/4-/5 point
	<b>ISECal</b> 2 bis 7 points

НеваРеактив

## inoLab® pH/ION 7320: Concentration determination with two measurement channels



inoLab® pH/ION 7320P

- **Two channel meter for simultaneous measurements of pH, ion concentration or ORP**
- **Data output via USB interface for rapid data transfer in \*.csv format or via an optionally built-in printer**
- **CMC function for measuring range monitoring with pH**

The inoLab® pH / ION 7320 is a specialized pH and ionic concentration meter that can measure pH or concentration on each of its two channels simultaneously.

### Reliable measurements

- Repeatable measurement results due to active automatic AutoRead function with detection of stable measuring values
- The CMC function for pH visualises the optimal measuring range for correct measurement
- Graphic display with plain text menus for convenient and safe operation
- Input of the electrode serial number for the GLP/AQA compliant documentation
- Transmission of all data in \*.csv format via USB interface to PC, formatted transfer to Excel (MultiLab® Importer, included in the delivery or as a download)
- Output directly in the meter via optional built-in printer

### Flexible and high performance:

- 1 to 5 point calibration with pH
- 2 to 7 point calibration with ion measurement, also non-linear
- Blank value correction, incremental methods: Known addition, known subtraction, sample addition, sample subtraction
- Concentration specification in different units
- Selectable AutoRead criterion
- DIN or BNC version
- Backlit graphic display with CMC display

Order information: inoLab® analogue benchtop Ion-selective meters

Model	Description	Order no.
inoLab® pH/ION 7320	Precise and convenient pH/mV/ISE 2 channel benchtop meter	1GA330
inoLab® pH/ION 7320P	Precise and convenient pH/mV/ISE 2 channel benchtop meter with built-in printer	1GA330P
inoLab® pH/ION 7320 BNC	Precise and convenient pH/mV/ISE 2 channel benchtop meter with BNC connectors	1GA340

# Portable meters for ion-selective measurement

3 year Warranty

IP 67

CE

## ProfiLine Multi 3320: The environment specialist

In addition to pH, ORP potential, conductivity and dissolved oxygen (electrochemical), the Multi 3320 also measures ion concentration with combined electrodes.

see page 49

ProfiLine Multi 3320

## ProfiLine pH/Cond 3320: Perfect in process

The most important parameters pH/mV and conductivity are complemented by the possibility for ISE measurement with combined ISE electrodes.

see page 50

ProfiLine pH/Cond 3320

## Specifications

ProfiLine		pH/ION 3310	
pH measurement		<b>pH</b>	-2.0 ... +20.0 ± 0.1 pH -2.00 ... +20.00 ± 0.01 pH -2.000 ... +19,999 ± 0,005 pH
		<b>mV</b>	± 1200.0 mV ± 0.3 mV ± (2500 ± 1) mV
		<b>Concentration</b> (mg/l, µmol/l, mg/kg, ppm, %)	0.000 ... 9.999 10.00 ... 99.99 100.0 ... 999.9 1000 ... 999999
ISE measurement			
<b>Temperature</b>			-5.0 ... 105.0 °C ± 0.1 °C
<b>CMC</b>			Yes
<b>Calibration</b>			1-, 2-, 3-, 4-, 5-point WTW technical buffers, DIN, NIST as well as further 22 buffer sets
		<b>ISECal</b>	2 to 7 point



## ProfiLine pH/ION 3310: pH-, mV- and concentration measurement from single source



ProfiLine pH/ION 3310

- **pH and ISE measurement**
- **2 to 7 point calibration, also non-linear**
- **Convenient menu control**

The pH/ION 3310 is a portable meter for outdoor use for combined pH and ISE measurements. All applications are covered with 1 to 5 point calibration for pH as well as a 2 to 7 point calibration for the direct potentiometric determination with ISE's, including the non-linear range.

### Reliable measurements

- Repeatable measurement results with the automatic AutoRead function for detecting stable measurement values
- The CMC function for pH visualises the optimal measuring range and supports correct measuring
- Graphic display with plain text menus for convenient and safe operation  
GLP/AQA compliant documentation
- Transmission of all data in \*.csv format via USB interface to PC; if desired, formatted transfer to Excel (MultiLab® Importer, included in the delivery or as download)

### Flexible and high performance:

- 1 to 5 point calibration for pH
- 2 to 7 point calibration for ion measurements, including the non-linear range
- Concentration readings in different units
- Backlit graphics display

Order information: Portable analogue ISE meters

No.	Description	Order no.
pH/ION	Professional pH/mV/ISE meter, IP 67 waterproof	2GA310

## Application table

Ion type	Application
Ammonium (NH <sub>4</sub> <sup>+</sup> )	Wastewater
Bromide (Br <sup>-</sup> )	Wine, plants
Calcium (Ca <sup>2+</sup> )	Milk products
Chloride (Cl <sup>-</sup> )	Drinking water, diet foods, mineral water
Copper (Cu <sup>2+</sup> )	Galvanic baths
Fluoride (F <sup>-</sup> )	Toothpaste, drinking water, cement
Nitrate (NO <sub>3</sub> <sup>-</sup> ) <sup>®</sup>	Baby food, fertiliser, wastewater
Potassium (K <sup>+</sup> ) <sup>®</sup>	Wine, fertiliser
Silver (Ag <sup>+</sup> ) <sup>®</sup>	Galvanic baths
Sodium (Na <sup>+</sup> ) <sup>®</sup>	Boiler feed water, diet foods, wine
Sulphide (S <sup>2-</sup> ) <sup>®</sup>	Proteins, sediments

## Ion-selective electrodes

Ion-selective and gas-sensitive electrodes are used for measuring the dissolved concentration of specific ions or gases in water. Similar to the pH electrode, the membrane interacts with the dissolved ions and delivers a concentration-dependent voltage signal that is converted to the corresponding measurement result.

### Combined ISE and GSE electrodes

- **Space-saving through integrated reference electrode**
- **11 different types available - broad selection of applications including ammonium measurement**
- **Slim and space-saving design with 12 mm shaft diameter**
- **Series 800 with 1 m fixed cable and DIN or BNC plug**

# Technical specifications and order information: inoLab® analogue Ion-selective electrodes

Combined ISE and GSE electrodes



	NH 500/2	Ca 800	Ag/S 800	Cl 800	CN 800
<b>Determinable ions</b>	Ammonium	Calcium, Magnesium	Silver, Sulphide	Chloride	Cyanide
<b>Membrane</b>	–	L	S	S	S
<b>Contains reference electrode</b>	Yes	Yes	Yes	Yes	Yes
<b>Measuring range</b>	0.02 to 900 mg/l, With 3 exchange heads and 50 ml electrolyte solution	0.02 ... 40000 mg/l 5 x 10 <sup>-7</sup> ... 1 mol/l	0.01 ... 108000 mg/l 10 <sup>-7</sup> ... 1 mol/l 0.003 ... 32000 mg/l 10 <sup>-7</sup> ... 1 mol/l	2 ... 35000 mg/l 5 x 10 <sup>-5</sup> ... 1 mol/l	0.2 ... 260 mg/l 8 x 10 <sup>-6</sup> ... 10 <sup>-2</sup> mol/l
<b>Bridge electrolyte</b>		ELY/BR/503	ELY/BR/503	ELY/BR/503	ELY/BR/503
<b>Ionic strength-adjusting solution</b>	MZ/NH3/CN	ISA/Ca	ISA/FK (Ag) or according to the operating instructions for sulphide measurement	ISA/FK	
<b>Standard solutions (conc. 10 g/l)</b>	ES/NH <sub>4</sub>	ES/Ca	Standard solutions must be prepared freshly <sup>③</sup>	ES/Cl	MZ/NH3/CN Standard solutions must be prepared freshly
<b>pH range</b>	4-12	2.5-11	2-12	2-12	0-14
<b>Order No. DIN variant</b>	106395 (S7 plug head)	106655	106651	106661	106663
<b>Order No. BNC variant</b>		106654	106650	106660	106662
<b>Order no. Exchange head</b>		106656			

① Solid electrode, L = Matrix electrode, G = Glass electrodes

② N/A

③ Preparation according to operating manual

④ Recipes and additionally required solutions are specified in the application report and operating manuals.

Combined ISE and GSE electrodes

ISE half cell



Cu 800	K 800	Br 800	F 800	NO 800	
Copper, Nickel®	Potassium®	Bromide	Fluoride, Aluminium, Phosphate®, Lithium®	Nitrate	Sodium
S	L	S	S	L	G
Yes	Yes	Yes	Yes	Yes	requires reference electrode R 503/D
0.0006 ... 6400 mg/l 10 <sup>-8</sup> ... 10 <sup>-1</sup> mol/l	0.04 ... 39000 mg/l 10 <sup>-6</sup> ... 1 mol/l	0.4 ... 79000 mg/l 5 x 10 <sup>-6</sup> ... 1 mol/l	0.02 ... sat. mg/l 10 <sup>-6</sup> ... sat. mol/l	0.4 ... 62000 mg/l,	0.05 ... 23000 mg/l
ELY/BR/503	ELY/BR/503/K	ELY/BR/503	ELY/BR/503	ELY/BR/503/N	ELY/BR/503
ISA/FK	ISA/K	ISA/FK	TISAB	TISAB/NO <sub>3</sub>	ISA/Na
ES/Cu	ES/K	ES/Br	ES/F	ES/NO <sub>3</sub>	ES/Na
2-6	2-12	1-12	5-7	2.5-11	>10
106665	106671	106653	106667	106675	106375 (S7 plug head)
106664	106670	106652	106666	106674	
	106672			106676	

# Dissolved Oxygen measurement



## Content

- 85 *Applications and meters overview*
- 86 *Benchtop dissolved oxygen meters*
  - 86 *inoLab® IDS - digital*
  - 87 *inoLab® - analogue*
  - 88 *inoLab® Oxi 7310 - analogue*
- 89 *Portable dissolved oxygen meters*
  - 89 *MultiLine® IDS - digital*
  - 90 *ProfiLine - analogue*
- 92 *Dissolved oxygen sensors*
  - 92 *IDS Optical dissolved oxygen sensor- digital*
  - 92 *Galvanic dissolved oxygen sensors - analogue*

# Applications and meters overview

The oxygen dissolved in water does not only play a crucial role for the organisms living in it, but is also an important factor in many technical processes. The dissolved oxygen measurement is actually a partial pressure measurement; the solubility depends on the partial pressure of the oxygen in the atmosphere above the liquid surface. It is measured either electrochemically with an amperometric sensor or optically via a fluorescence method with an optical dissolved oxygen sensor.

- ✓ yes
- yes

- ✓ recommended
- ✓ recommended for some applications
- not recommended

	Digital			Analogue	Digital			Analogue			
	Benchtop dissolved oxygen meters						Portable dissolved oxygen meters				
	inoLab® IDS			inoLab®	MultiLine® IDS			ProfiLine			
	Multi 9630	Multi 9620	Multi 9310	Oxi 7310	Multi 3630	Multi 3620	Multi 3510	Multi 3320	Oxi 3310	Oxi 3205	
2 parameters simultaneously	✓	✓			✓	✓		✓			
3 parameters simultaneously	✓				✓						
Dissolved oxygen optical	●	●	●		●	●	●				
Gelöster Sauerstoff galvanisch				●				●	●	●	
Additional parameters	●	●	●		●	●	●	●			
Routine measurement	✓	✓	✓	✓	✓	✓	✓	✓	✓	✓	
Routine measurement with documentation	✓	✓	✓	✓	✓	✓	✓	✓	✓	–	
AQA with documentation	✓	✓	✓	✓	✓	✓	✓	✓	✓	–	
R&D High resolution and precision	✓	✓	✓	✓	✓	✓	✓	✓	✓	–	
Control measurements	✓	✓	✓	✓	✓	✓	✓	✓	✓	–	
LIMS connection	✓	✓	✓	✓	✓	✓	✓	✓	✓	–	
Quality assurance	✓	✓	✓	✓	✓	✓	✓	✓	✓	–	
Education	✓	✓	✓	✓	✓	✓	✓	✓	✓	✓	
Service	–	–	–	–	✓	✓	✓	✓	✓	✓	
Laboratory measurements	✓	✓	✓	✓	✓	✓	✓	✓	✓	✓	
Field measurements	–	–	–	–	✓	✓	✓	✓	✓	✓	
Depth measurements	–	–	–	–	✓	✓	✓	–	–	–	
PC connection	✓	✓	✓	✓	✓	✓	✓	✓	✓	–	
Memory	✓	✓	✓	✓	✓	✓	✓	✓	✓	–	
USB interface	✓	✓	✓	✓	✓	✓	✓	✓	✓	–	
Graphic display			✓	✓				✓	✓	✓	
Color graphic display	✓	✓			✓	✓					
Compatible sensors											
Digital IDS electrodes											
IDS Optical dissolved oxygen sensor	33	✓	✓	✓		✓	✓	✓			
Analogue electrodes											
Dissolved oxygen sensors	92				✓				✓	✓	
Self-stirring dissolved oxygen sensor	93				✓						
		Multi 9630	Multi 9620	Multi 9310	Oxi 7310	Multi 3630	Multi 3620	Multi 3510	Multi 3320	Oxi 3310	Oxi 3205
see page		40	40	41	88	44	45	46	49	91	91

# Benchtop dissolved oxygen meters

Dissolved oxygen is mainly used to determine the biochemical oxygen demand (BOD), but also as a parameter for other biological and chemical processes such as corrosion.

## inoLab® IDS – digital



Dissolved oxygen measurement with the new digital multi-parameter meters inoLab® IDS:

### inoLab® Multi 9630 IDS: Measure three parameters simultaneously

High-tech for demanding laboratory applications. The digital inoLab® multi-parameter meter for IDS sensors for parallel measurement of the same or different parameters. Up to three sensors can be connected. The optical sensor FDO® 925 is also suitable and approved for BOD measurement.



inoLab® Multi 9630 IDS

see page 40

### inoLab® Multi 9620 IDS: Measure two parameters simultaneously

As inoLab® Multi 9630 IDS, but up to two sensors can be connected.



inoLab® Multi 9620 IDS

see page 40

### inoLab® Multi 9310 IDS: Digital individual parameter solution

The new inoLab® Multi 9310 IDS is well suited for dissolved oxygen measurement in the laboratory. The IDS technology allows optimized measurements and efficient documentation in the simplest manner.



inoLab® Multi 9310 IDS

see page 41

# inoLab® - analogue

All benchtop meters are available in application-oriented sets including sensors and accessories.



inoLab® Oxi 7310

**inoLab**  
innovations that make sense



## Technical specifications: Benchtop oxygen meter inoLab® Oxi 7310

inoLab® Oxi 7310 (all values ±1 digit)	
<b>Concentration</b>	0.000 ... 20.00 mg/l ± 0.5 % 0 ... 90 mg/l ± 0.5 %
<b>Saturation</b>	0.0 ... 200.0 % ± 0.5 % of measured value 0 ... 600 % ± 0.5 % of measured value
<b>Partial pressure</b>	0 ... 200,0 hPa, 0 ... 1250 hPa
<b>Temperature</b>	-5.0 ... 105.0 °C ± 0.1 °C
<b>Celsius/Fahrenheit</b>	Yes
<b>AutoRead</b>	Can be switched automatically/manually
<b>Calibration</b>	Calibration against external standard
<b>Calibration memory</b>	retrieve up to 10 calibrations
<b>Built-in pressure sensor</b>	Yes
<b>Display</b>	LCD graphics, backlit
<b>Data memory</b>	Manual 500/5000 automatic
<b>Logger</b>	Manually/time-controlled
<b>Interface</b>	Mini USB
<b>Printer (optional)</b>	Thermal printer, width 58 mm
<b>Power Supply</b>	Universal power supply 100 to 240 V, 50/60 Hz, 4 x 1.5 V AA or 4 x 1.2 V NiMH battery pack



## inoLab® Oxi 7310: reliable documentation of dissolved oxygen



inoLab® Oxi 7310P (with built-in printer)

- **USB interface for rapid data transfer**
- **Data output in \*.csv-Format or via optionally built-in printer**
- **Calibration against external standard possible**

The inoLab® Oxi 7310 is perfectly suited for precision measurement and automatic GLP/AQA compliant documentation in quality laboratories of all industries. The meter has a special connector for the connection of the self-stirring dissolved oxygen sensor StirrOx® G. Also available with optionally built-in printer.

### Reliable measurement

- Repeatable measurement results due to active automatic AutoRead function with detection of stable measuring values
- Easy calibration in water vapour saturated air
- Graphic display with clear text menus for convenient and safe operation

### GLP/AQA compliant documentation

- Alphanumeric input of the electrode serial number
- Transfer of all data in \*.csv format via USB interface at the PC, formatted takeover into Excel (MultiLab® Importer)
- Output possible via optionally built-in printer

### Flexible and high performance:

- Measures partial pressure, concentration and saturation
- Salinity correction
- Storage for large measurement series
- Connection for self-stirring dissolved oxygen sensor StirrOx® G



## Order information: Benchtop dissolved oxygen meters

Model	Description	Bestell-Nr.
inoLab® Oxi 7310 SET 1	Professional, menu-controlled benchtop D.O. meter for GLP/AQA-compliant measurements/documentation. Set with galvanic oxygen sensor CellOx® 325 and accessories.	1BA301
inoLab® Oxi 7310 SET 4	Professional, menu-controlled benchtop D.O. meter for GLP/AQA-compliant measurements/documentation. Set with self-stirring galvanic oxygen electrode StirrOx® 325 and accessories.	1BA304
inoLab® Oxi 7310P	Professional, menu-controlled benchtop D.O. meter for GLP/AQA-compliant measurements/documentation with built-in thermo printer.	1BA300P

Further details see price list or [www.WTW.com](http://www.WTW.com).

# Portable dissolved oxygen meters

The oxygen measurement plays a large role in mobile environment analytics. Portable systems are used in the water wastewater treatment plant for monitoring stationary measurement, fish farming, in limnology and many other fields.

## MultiLine® IDS - digital



Portable optical dissolved oxygen measurement with the new digital MultiLine® multi-parameter meters:



MultiLine® Multi 3630 IDS

### Multi 3630 IDS: Measure three parameters simultaneously

Three galvanically isolated measurement channels, can be freely combined for the same or different parameters. It also allows oxygen measurement in conjunction with a depth sonde of the MPP IDS type.

see page 44



MultiLine® Multi 3620 IDS

### Multi 3620 IDS: Measure two parameters simultaneously

Two galvanically isolated measurement channels, can be freely combined for the same or different parameters. Measures dissolved oxygen also in connection with other parameters.

see page 45



MultiLine® Multi 3510 IDS

### Multi 3510 IDS: Digital single parameter solution

The single channel multi-parameter meter Multi 3510 IDS is ideally suited for portable dissolved oxygen measurement in wastewater treatment plants, surface waters and industrial applications.

see page 46

## ProfiLine - analogue



ProfiLine® Multi 3320

### ProfiLine Multi 3320: The environment specialist

Dissolved oxygen, pH/ORP, ISE and conductivity: the Multi 3320 is a perfect meter for environmental monitoring with electrochemical sensors. Especially in combination with the dissolved oxygen, applications can be covered in surface water, in fish farming and in wastewater treatment plants.

see page 49

НеваРеактив

# ProfiLine – analogue

All analogue ProfiLine oxygen meters are also available in application-oriented carrying case kits.



3 year warranty IP 67 CE

ProfiLine Oxi 3310 Set 1



## Technical specifications: ProfiLine portable oxygen meters

Models	Oxi 3205	Oxi 3310
<b>Measuring ranges/ Dissolving/ accuracy</b>	O <sub>2</sub> conc. 0.00 ... 20.00 mg/l (20.0 mg/l*) ±0.5 % of measured value O <sub>2</sub> saturation 0 ... 90 mg/l ±0.5 % of measured value O <sub>2</sub> partial pressure 0.0 ... 200.0 % (200 %*) ±0.5 % of measured value temperature 0 ... 600 % ±0.5 % of measured value 0,0 ... 200.0 mbar (200 mbar*) ±0.5 % of measured value; 0 ... 1250 mbar ±0.5 % v. Mw. -5.0 ... +105.0 °C ±0.1 °C	
<b>Temperature compensation</b>	Better than 2 % at 0 ... +40 °C	
<b>Air pressure compensation</b>	Automatic with integrated pressure sensor (500 ... 1100 mbar)	
<b>Salinity correction</b>	0 or 35 fixed	
<b>Calibration</b>	OxiCal® fast calibration in OxiCal®-SL or OxiCal®-D	
<b>Data memory/logger</b>	-	manual 500/5000 automatic
<b>Display</b>	LCD graphics, backlit	
<b>Continuous operation</b>	Up to 800 h without/100 h with illumination	

## Order information: ProfiLine portable oxygen meters

Model	Description	Order no.
Oxi 3205 Set 1	Robust and waterproof oxygen meter in a carrying case kit with galvanic dissolved oxygen sensor CellOx® 325 and accessories	2BA101
Oxi 3310 Set 1	Professional, waterproof oxygen meter with data logger and USB interface in the carrying case with galvanic dissolved oxygen sensor CellOx® 325 and accessories	2BA301

For additional products, see price list or [www.WTW.com](http://www.WTW.com)

НеваРеактив

## ProfiLine Oxi 3310: Measure and document dissolved oxygen



ProfiLine Oxi 3310

The Oxi 3310 is a robust portable meter with built-in data logger for recording series of measurements.

### Reliable measurements

- Repeatable measuring results due to automatic AutoRead function
- Automatic barometric pressure compensation
- Silicon keyboard with tactile key click and acoustic feedback

### GLP/AQA compliant documentation

- Data transfer in \*.csv format via USB interface at the PC
- Formatted takeover into Excel (MultiLab® Importer, included in the delivery or as a download)

### Flexible and high performance:

- Measures partial pressure, concentration and saturation
- Built-in salinity correction
- Memory for large measurement series

- **Waterproof USB interface for rapid data transfer**
- **Data output in \*.csv-Format**
- **Calibration against external standard possible (Winkler titration)**

## ProfiLine Oxi 3205: Measure dissolved oxygen in a simple manner



ProfiLine Oxi 3205

The Oxi 3205 is a easy, reliable meter for routine measurement

- Repeatable measurement results due to active automatic AutoRead function with detection of stable measuring values
- Simple operation: Automated functions reduce the number of keys (6)
- OxiCal® Air calibration
- Waterproof 8 pin socket for measurements under outdoor conditions

- **Compatible with CelOx® and DurOx® probes**
- **Backlit graphics display**
- **Automatic barometric pressure compensation**

# Dissolved oxygen sensors

## IDS optical dissolved oxygen sensor-digital

Optical measurement is the most advanced method of determining dissolved oxygen. Using fluorescence quenching as described in DIN ISO 17289, the fluorescence signal of special dyes changes as a function of the oxygen concentration. This is measured, and converted to dissolved oxygen concentration. The method is described in DIN ISO 17289.

The optical dissolved oxygen sensor is only available in the IDS system, and is described in the multi-parameter measurement chapter.



FDO® 925/FDO® 925-P

see page 33

## Galvanic dissolved oxygen sensors - analogue

The electrochemical method is the second currently used method for measuring the dissolved oxygen. It measures oxygen proportional to the current signal of a polarographic or galvanic dissolved oxygen sensor according to DIN ISO 5814.

- **Universal application due to wide measuring range between 0 and 50 mg/l**
- **Easy handling through proven technology**
- **Sensors available for special applications (fish farming, BOD measurement)**
- **Simple calibration in water vapour saturated air (calibration vessel included)**

### Technical specifications: Galvanic dissolved oxygen sensors - analogue

	<b>CellOx® 325</b>	<b>DurOx® 325-3</b>	<b>StirrOx® G</b>
<b>Order no.</b>	201533	201570	2013425
<b>Method</b>	Electrochemical/galvanic	Electrochemical/galvanic	Electrochemical/galvanic
<b>Response time T99 (20 °C)</b>	< 60 s	< 125 s	< 45 s
<b>Measuring range</b>	<b>Concentration</b>	0 ... 50 mg/l	0 ... 50 mg/l
	<b>Saturation</b>	0 ... 600 %	0 ... 600 %
	<b>Partial pressure</b>	0 ... 1250 hPa	0 ... 1250 hPa
<b>Temperature</b>	0 ... 50 °C	0 ... 50 °C	0 ... 50 °C
<b>Shaft material</b>	POM, stainless steel	POM, stainless steel	POM, stainless steel
<b>Shaft length</b>	145 mm	110 mm	49 (83) mm
<b>Diameter</b>	15.3 mm	17.5 mm	12 mm
<b>Cable length</b>	1.5 m (further cable lengths see price list)	3 m	2 m



CellOx® 325



DurOx® 325



StirrOx® G

### CellOx® 325

This universal galvanic dissolved oxygen sensor with IMT temperature compensation can be used both in the laboratory and in the field. It is available in versions with cable lengths up to 20 m.

### DurOx® 325

Thanks to a special membrane technology, this well-priced galvanic dissolved oxygen sensor is particularly insensitive to strongly fluctuating measured values, for example when testing stationary oxygen meters in the wastewater process. Also suitable for training purposes.

### StirrOx® G

Special dissolved oxygen sensor for the BOD (biochemical oxygen demand) measurement. With a motor-operated stirring paddle for mixing the samples and flow to the sensor. This probe features extremely low intrinsic oxygen consumption and built-in membrane monitoring.

## Order information: Accessories for analogue galvanic dissolved oxygen sensors

Model	Description	Order no.
ZBK-D	Accessories box with replacement and maintenance kit for DurOx® sensors.	201578
ZBK 325	Replacement and maintenance kit for dissolved oxygen sensors CellOx® 325	202706
ZBK ST	Accessories box with replacement and maintenance kit for dissolved oxygen sensors StirrOx® G.	202710
WP 90/3	3 changeable membrane heads suitable for all dissolved oxygen sensors, except StirrOx® G, DurOx® 325	202725
WP3-ST	3 changeable membrane heads for StirrOx® G	202738
WP3-D	3 changeable membrane heads for DurOx® sensors.	202740
RL-G	Cleaning solution for galvanic dissolved oxygen sensors StirrOx® G, CellOx® 325, DurOx® 325 and TA 197 Oxi, 1 bottle of 30 ml	205204
Y/G	Electrolyte for galvanic dissolved oxygen sensors StirrOx® G, CellOx® 325, DurOx® 325	205217
S 925	Replacement membrane cap for optical dissolved oxygen sensor	201310

For additional products, see price list or [www.WTW.com](http://www.WTW.com)

# Conductivity measurement



## Content

- 95 *Applications and meters overview*
- 96 *Benchtopy conductivity meters*
  - 96 *inoLab® Multi IDS - digital*
  - 97 *inoLab® - analogue*
- 100 *Portable conductivity meters*
  - 100 *MultiLine® IDS - digital*
  - 101 *ProfiLine Cond - analogue*
- 105 *Conductivity cells*
  - 105 *IDS conductivity cells - digital*
  - 106 *Conductivity cells - analogue*
- 110 *Calibration and test kits*

# Applications and meters overview

The conductivity is a sum parameter, as all ions dissolved in the water contribute to the conductivity. It is detected with so-called measuring cells, which are immersed in the sample. Determining the ratio of applied voltage and flowing current in conjunction with a geometric factor resulting from the cell provides the desired measured value.

	Benchtop conductivity meters					Portable conductivity meters							
	Digital			Analogue		Digital			Analogue				
	inoLab® IDS			inoLab®		MultiLine® IDS			ProfiLine				
	Multi 9630	Multi 9620	Multi 9310	Cond 7310	Cond 7110	Multi 3630	Multi 3620	Multi 3510	Multi 3320	pH/Cond 3320	Cond 3310	Cond 3110	
2 parameters simultaneously	✓	✓				✓	✓		✓	✓			
3 parameters simultaneously	✓					✓							
Additional parameters	●	●	●			●	●	●	●	●			
Routine measurements	✓	✓	✓	✓	✓	✓	✓	✓	✓	✓	✓	✓	
Routine measurements with documentation	✓	✓	✓	✓	–	✓	✓	✓	✓	✓	✓	–	
AQA with documentation	✓	✓	✓	✓	–	✓	✓	✓	✓	✓	✓	–	
R&D High resolution and precision	✓	✓	✓	✓	–	✓	✓	✓	✓	✓	✓	–	
Control measurements	✓	✓	✓	✓	–	✓	✓	✓	✓	✓	✓	–	
LIMS connection	✓	✓	✓	✓	–	✓	✓	✓	✓	✓	✓	–	
Quality assurance	✓	✓	✓	✓	–	✓	✓	✓	✓	✓	✓	–	
Education	✓	✓	✓	✓	✓	✓	✓	✓	✓	✓	✓	✓	
Service	–	–	–	–	–	✓	✓	✓	✓	✓	✓	✓	
Laboratory measurements	✓	✓	✓	✓	✓	✓	✓	✓	✓	✓	✓	–	
Field measurements	–	–	–	–	–	✓	✓	✓	✓	✓	✓	✓	
Depth measurements	–	–	–	–	–	✓	✓	✓	–	–	✓	✓	
PC connection	✓	✓	✓	✓		✓	✓	✓	✓	✓	✓		
Memory	✓	✓	✓	✓		✓	✓	✓	✓	✓	✓		
USB interface	✓	✓	✓	✓		✓	✓	✓	✓	✓	✓		
Graphic display			✓	✓					✓	✓	✓		
Color graphic display	✓	✓				✓	✓	✓					
Compatible sensors													
Digital IDS electrodes													
IDS conductivity cells	34	✓	✓	✓		✓	✓	✓					
Analogue electrodes													
Conductivity cells	106				✓	✓			✓	✓	✓	✓	
		Multi 9630	Multi 9620	Multi 9310	Cond 7310	Cond 7110	Multi 3630	Multi 3620	Multi 3510	Multi 3320	pH/Cond 3320	Cond 3310	Cond 3110
see page		40	40	41	98	99	44	45	46	49	50	103	104



# Benchtop conductivity meters

The use of different conductivity cells is common in the laboratory. The IDS technology is showing clear advantages here: The error-free automatic transmission of cell constants and preset temperature compensation for reliable measurement results.

## inoLab® IDS – digital



Conductivity measurement in the quality laboratory with the new digital multi-parameter measuring instruments inoLab® IDS

### inoLab® Multi 9630 IDS: Measure three parameters simultaneously

The digital inoLab® multi parameter meters for IDS sensors for parallel measurement of the same or different parameters. Up to three sensors can be connected. The IDS conductivity cells cover a wide range of applications. Due to the galvanic isolation of the measuring channels, there is no interference between the connected sensors, e.g. IDS pH electrodes.



inoLab® Multi 9630 IDS

see page 40

### inoLab® Multi 9620 IDS: Measure two parameters simultaneously

As inoLab® Multi 9630 IDS, but up to two sensors can be connected.



inoLab® Multi 9620 IDS

see page 40

### inoLab® Multi 9310 IDS: Digital individual parameter solution

The inoLab® Multi 9310 IDS works with any IDS conductivity cell and can cover all laboratory related tasks.



inoLab® Multi 9310 IDS

see page 41

# inoLab® - analogue

**inoLab**  
innovations that make sense

**3** year warranty

IP 43

CE

All benchtop meters are available in application-oriented sets with sensors and accessories.



inoLab® Cond 7310 SET 1

## Technical specifications: inoLab® analogue benchtop conductivity meters

	<b>inoLab® Cond 7310</b> all values ±1 digit	<b>inoLab® Cond 7110</b> all values ±1 digit
<b>Conductivity</b>	0 µS/cm ... 1000 mS/cm ± 0.5 % of measured value	0 µS/cm ... 1000 mS/cm ± 0.5 % of measured value
<b>Salinity</b>	0.0 ... 70.0 (according to IOT) 0.00 ... 20 MOhm cm	0.0 ... 70.0 (according to IOT) 0.00 ... 20 MOhm cm
<b>TDS</b>	1 ... 1999 mg/l, 0 to 199.9 g/l	0 ... 1999 mg/l
<b>Temperature</b>	-5.0 ... 105.0 °C ± 0.1 °C	-5.0 ... 105.0 °C ± 0.1 °C
<b>Cell constants</b>	Fix 0.01 cm <sup>-1</sup> , can be calibrated 0.450...0.500 cm <sup>-1</sup> , 0.800 to 0.880 cm <sup>-1</sup> , adjustable 0.09 ... 0.110 cm <sup>-1</sup> 0.250 ... 25.0 cm <sup>-1</sup>	0.450 ... 0.500 cm <sup>-1</sup> 0.09 ... 0.110 cm <sup>-1</sup> 0.800 to 0.880 cm <sup>-1</sup> , 0.25 ... 2.5 cm <sup>-1</sup> , fixed 0.01 cm <sup>-1</sup>
<b>Calibration</b>	1-point	1-point
<b>Tref</b>	20°C/25°C	20°C/25°C
<b>Temperature compensation</b>	nLF, linear 0.000 to 10.000 %, disengageable	nLF, linear 0.000 to 3000 %, disengageable

## inoLab® Cond 7310: Reliable conductivity documentation



inoLab® Cond 7310

- **USB interface for rapid data transfer**
- **Data output in \*.csv-Format or via optionally built-in printer**
- **Mains and battery operation inoLab® Cond 7310**

The inoLab® pH 7310 is perfectly suited for precision measurement and automatic GLP/AQA compliant documentation in quality laboratories of all industries. Also available with optionally installed printer.

### Reliable measurements

- Repeatable measurement results due to active automatic AutoRead function for the detection of stable measured values
- The sensor symbol informs about the condition of the electrode
- Graphic display with plain text menus for convenient and safe operation

### GLP/AQA compliant documentation

- Alphanumeric input of the conductivity cell serial number
- Transfer of all data in \*.csv format via USB interface at the PC, formatted takeover into Excel (MultiLab® Importer)
- Output possible via optionally installed printer

### Flexible and high performance:

- For all modern WTW conductivity cells
- Measures TDS, salinity and specific resistance
- Backlit graphics display for brilliant representation
- Suitable for measurements according to pharmacopoeia

## inoLab® Cond 7110: Exact conductivity measurement



inoLab® Cond 7110

- Simple, intuitive operation
- Measurement range up to 1000 mS/cm
- Including stand and sensor holder

The inoLab® Cond 7110 is a laboratory routine conductivity meter with a large display and all functions that make accurate measurements easy.

### Measuring certainty

- Repeatable measurement results due to active automatic AutoRead function with independent detection of stable measuring values
- Calibration timer for regularly checking the conductivity cells
- Precise measured value recording through high-quality electronics

### Flexible and high performance:

- Measures conductivity, TDS and salinity
- Connection of special measuring cells possible
- Linear, non-linear (nlf) and selectable temperature compensation
- Simple, intuitive operation
- Measurement range up to 1000 mS/cm
- Including stand and sensor holder



## Order information: inoLab® analogue benchtop conductivity meters

Model	Description	Order no.
inoLab® Cond 7110 SET 1	Simple, easy-to-use conductivity benchtop meter for routine measurements. In a set with conductivity cell TetraCon® 325	1CA101
inoLab® Cond 7310P	Comfortable, menu-controlled conductivity benchtop meter for measurements/GLP/AQA compliant documentation With built-in thermal printer Single instrument	1CA300P
inoLab® Cond 7310 SET 1	Convenient, menu-controlled conductivity benchtop meter for measurements/GLP/AQA compliant documentation In a set with conductivity cell TetraCon® 325	1CA301

For Accessories and cables, see price list or [www.WTW.com/de](http://www.WTW.com/de)

# Portable conductivity meters

## MultiLine® IDS - digital

Portable conductivity measurement in the process and in the field with the new digital MultiLine® multi-parameter instruments:



### Multi 3630 IDS: Measure three parameters simultaneously

Three galvanically isolated measurement channels can be used for any combination of parameters. It enables conductivity measurement also in conjunction with a MPP IDS depth sonde. Galvanic isolation eliminates the possibility of interference with other sensors.

*see page 44*



MultiLine® Multi 3630 IDS

### Multi 3620 IDS: Measure two parameters simultaneously

Two galvanically isolated measurement channels can be used for any combination of parameters. Perfect for conductivity measurement in combination with pH measurement.

*see page 45*



MultiLine® Multi 3620 IDS

### MultiLine® Multi 3510 IDS: Digital single parameter solution

The single channel multi-parameter meter Multi 3510 IDS is perfect for conductivity measurement of ultra-pure water up to concentrated solutions.

*see page 46*



MultiLine® Multi 3510 IDS

# ProfiLine - analogue

All portable meters are available in application specific kits including sensors and accessories in a carrying case.



3 year warranty IP 67 CE

ProfiLine Cond 3310 SET 1

## Technical specifications: ProfiLine analogue portable conductivity meters

ProfiLine ...	Cond 3110	Cond 3310
<b>Measuring ranges/resolution/accuracy</b>	<b>Conductivity</b> 0,0 ... 1000 mS/cm ±0,5 % of the measured value	0,0 ... 1000 mS/cm ±0,5 % of the measured value 1.999 µS/cm (with K=0.01 cm <sup>-1</sup> ) 0.00 ... 19.99 µS/cm (with K= 0.1 cm <sup>-1</sup> )
	<b>Temperature</b> 5.0 °C ... +105.0 °C ±0.1 °C	-5.0 °C ... +105.0 °C ±0,1 °C
	<b>Salinity</b> 0.0 ... 70.0 (as per IOT)	0.0 ... 70.0 (as per IOT)
	<b>TDS</b>	0 ... 1999 mg/l, 0 ... 199.9 g/l,
	<b>Spec. resistance</b>	0.00 ... 999 MΩcm
<b>Reference temperature</b>	selectable 20 °C or 25 °C	selectable 20 °C or 25 °C
<b>Cell constant</b>	<b>fixed:</b> 0.475 cm <sup>-1</sup>	0.475 cm <sup>-1</sup> , 0.010 cm <sup>-1</sup>
	<b>with calibration:</b> 0.450 ... 0.500 cm <sup>-1</sup> , 0.800 ... 0.880 cm <sup>-1</sup>	0.450 ... 0.500 cm <sup>-1</sup> , 0.800 ... 0.880 cm <sup>-1</sup>
	<b>adjustable:</b> -	0.090 ... 0.110 cm <sup>-1</sup> , 0.250 ... 25.000 cm <sup>-1</sup>
<b>Temperature compensation</b>	automatic	can be switched automatically/manually
<b>Temperature coefficient</b>	• Non-linear function of natural waters (nLF) as per EN 27 888	• Non-linear function of natural waters (nLF) as per EN 27 888 and ultra-pure water function • Linear compensation of 0.000 ... 10.000 %/K • No compensation
<b>Data memory/logger</b>	-	manual 200/5000 automatic
<b>Display</b>	7-Segment LCD, customized	LCD graphics, backlight
<b>Power consumption</b>	up to 1000 hours	up to 800 h without/100 h with illumination

Неварреактив

## ProfiLine Multi 3320: The environment specialist

The Multi 3320 for the measurement of conductivity, pH, ISE, ORP, and dissolved oxygen is a perfect analogue meter for environmental monitoring with electrochemical sensors. With conductivity measurement, all applications can be covered with standard, special and ultra-pure water measuring cells.

see page 49



ProfiLine Multi 3320

## ProfiLine pH/Cond 3320: Perfect in process

Conductivity, pH / ORP, ISE: the pH/Cond 3320 is a perfect meter also in portable process monitoring with electrochemical sensors. With conductivity measurement, all types of measurement can be covered with standard, special and ultra-pure water measuring cells, alone or in combination pH, ORP or ISE.

see page 50



ProfiLine pH/Cond 3320



Неварреактив

## ProfiLine Cond 3310: Reliable conductivity measurement with documentation



ProfiLine Cond 3310

- **Waterproof USB interface for rapid data transfer**
- **Data output in \*.csv-Format**
- **Measuring range 0.001 µS/cm to 1000 mS/cm**

The Cond 3310 is a combination of a robust portable meter and a data logger for anyone who wants to record measured data automatically and evaluate them based on EDP.

### Reliable measurements

- Repeatable measurement results due to active automatic AutoRead function with detection of stable measuring values
- Automatic temperature compensation, also disengageable, linear compensation up to 10%/K
- Silicon keyboard with tactile key click and optional protection for field use

### GLP/AQA compliant documentation

- Large memory for 500 manual and 5000 automatically generated entries
- Transfer of all data in \*.csv format via USB interface at the PC; formatted takeover into Excel (MultiLab® Importer)

### Flexible and high performance:

- Measures conductivity, salinity, TDS and specific resistance
- Data transfer directly in Excel
- Suitable for measurements according to pharmacopoeia





## ProfiLine Cond 3110: Easy conductivity measurement



ProfiLine Cond 3110

- **Compatible with TetraCon® 325 or KLE 325**
- **Automatic temperature compensation**
- **Salinity**

The Cond 3110 is a simple, reliable conductivity meter with automatic nIF temperature compensation according to DIN EN 27888 for routine measurement in natural waters and wastewater.

### Reliable measurement

- Repeatable measurement results due to active automatic AutoRead function for the detection of stable measured values
- Secure operation: Automated functions reduce the number of keys (6)
- A waterproof 8-pin socket enables reliable measurement also in a humid environment.

### Easy and reliable:

- Easily readable display for measured value and temperature
- Silicon keyboard with tactile key click, also operable with gloves
- Sets for field use with proven electrodes and carrying case
- Suitable for TetraCon® 325 or KLE 325
- Automatic temperature compensation
- Salinity

## Order information: Conductivity meters

Model	Description	Order no.
Cond 3110 SET 1	Easy-to-use, robust conductivity meter with large LCD display, for mobile routine measurement of 2- and 4 electrode cells, set with TetraCon® 325.	2CA101
Cond 3310 SET 1	Professional, field-proven conductivity meter with backlit LCD graphic display for mobile measurement, with data logger, USB interface. Set with TetraCon® 325	2CA301

For additional accessories and cables, see price list or [www.WTW.com/de](http://www.WTW.com/de)

НеваРеактив

# Conductivity cells

Depending on the application, we provide electrodes made of graphite or stainless steel to ensure that they do not chemically react with the measured sample.

## Four electrode conductivity cells

- Universal application area due to wide measuring range between 1  $\mu\text{S}/\text{cm}$  and 2000  $\text{mS}/\text{cm}$
- Only one calibration point required due to linearity over the entire measuring range
- Measuring cells in different designs for almost all applications
- Highest accuracy through high-precision manufacturing
- Large application range in aqueous solutions through unique electrode technology

## Two electrode measuring cells made of stainless steel

- Optimised measuring cells, especially for use in ultra-pure water measurement
- No disturbances due to  $\text{CO}_2$  introduction with stainless steel measuring cells with flow-through vessels
- Precise measurement in the lower measuring range due to optimised geometry
- Suitable for ultra-pure water measurement according to pharmacopoeia

## Two electrode measuring cell made of graphite

- Robust measuring cell for simple measurements and in teaching and training
- Robust design with durable epoxy shaft
- For all aqueous samples
- For all current conductivity meters

# IDS Conductivity cells – digital



A selection of two electrode and four electrode conductivity cells for covering a wide range of applications, from ultra-pure water to viscous samples can be found in the chapter “Multi-parameter measurement”.

see page 34



from left to right: the digital IDS sensors (1) TetraCon® 925, (2) LR 925/01, (3) TetraCon® 925 / C, (4) TetraCon® 925 / LV; the wireless ready IDS plug head electrodes (5) TetraCon® 925-P, (6) TetraCon® 925 / LV-P, (7) LR 925/01-P

НеваРеактив

# Conductivity cells - analogue

## For every application



Technical specifications: Conductivity cells - analogue

### Universal applications

	TetraCon® 325	TetraCon® 325-3	TetraCon® 325-6	TetraCon® 325-10	TetraCon® 325-15	TetraCon® 325-20
<b>Order no.</b>	301960	301970	301971	301972	301973	301974
<b>Type</b>	4 electrode	4 electrode	4 electrode	4 electrode	4 electrode	4 electrode
<b>Electrode material</b>	Graphite	Graphite	Graphite	Graphite	Graphite	Graphite
<b>Flow-through vessel</b>	-	-	-	-	-	-
<b>Shaft material</b>	Epoxy	Epoxy	Epoxy	Epoxy	Epoxy	Epoxy
<b>Shaft length</b>	120 mm	120 mm	120 mm	120 mm	120 mm	120 mm
<b>Cell constant</b>	0.475 cm <sup>-1</sup>	0.475 cm <sup>-1</sup>	0.475 cm <sup>-1</sup>	0.475 cm <sup>-1</sup>	0.475 cm <sup>-1</sup>	0.475 cm <sup>-1</sup>
<b>Diameter</b>	15.3 mm	15.3 mm	15.3 mm	15.3 mm	15.3 mm	15.3 mm
<b>Cable length</b>	1.5 m	3 m	6 m	10 m	15 m	20 m
<b>Measuring range</b>	1 µS/cm to 2000 mS/cm	1 µS/cm to 2000 mS/cm	1 µS/cm to 2000 mS/cm	1 µS/cm to 2000 mS/cm	1 µS/cm to 2000 mS/cm	1 µS/cm to 2000 mS/cm
<b>Temperature range</b>	0 to 100 °C	0 to 100 °C	0 to 100 °C	0 to 100 °C	0 to 100 °C	0 to 100 °C
<b>min. immersion depth</b>	36/120 mm	36/120 mm	36/120 mm	36/120 mm	36/120 mm	36/120 mm

## Special applications

	TetraCon® 325/C	TetraCon® 325/S
<b>Order no.</b>	301900	301602
<b>Type</b>	4 electrode	4 electrode
<b>Electrode material</b>	Graphite	Graphite
<b>Shaft material</b>	Epoxy	Epoxy
<b>Shaft length</b>	120 mm	120 mm
<b>Cell constant</b>	0.475 cm <sup>-1</sup>	0.491 cm <sup>-1</sup>
<b>Diameter</b>	15.3 mm	15.3 mm
<b>Cable length</b>	1.5 m	1.5 m
<b>Measuring range</b>	1 µS/cm ... 2000 mS/cm	1 µS/cm ... 2000 mS/cm
<b>Temperature range</b>	0 ... 100 °C	0 ... 100 °C
<b>Temperature probe</b>	NTC 30 kOhm	NTC 30 kOhm
<b>min./max. immersion depth</b>	36/120 mm	40/120 mm

## Low conductivities

	LR 325/01	LR 325/001
<b>Order no.</b>	301961	301963
<b>Electrode material</b>	Stainless steel	Stainless steel
<b>Flow-through vessel</b>	Glass	Stainless steel
<b>Shaft material</b>	Stainless steel	Stainless steel
<b>Shaft length</b>	120 mm	120 mm
<b>Cell constant</b>	0.1 cm <sup>-1</sup>	0.01 cm <sup>-1</sup>
<b>Diameter</b>	12 mm	20 mm
<b>Cable length</b>	1.5 m	1.5 m
<b>Measuring range</b>	0.001 ... 200 µS/cm	0.0001 µS ... 30 µS/cm
<b>Temperature range</b>	0 ... + 100 °C	0 ... + 100 °C
<b>Temperature probe</b>	NTC 30 kOhm	NTC 30 kOhm
<b>Filling volume</b>	17 ml (without sensor)	Approx. 10 ml (without sensor)
<b>min./max. immersion depth</b>	30/120 mm	40/120 mm

## Simple applications and flow-through measurement in the laboratory

	KLE 325	TetraCon® DU/T or DU/TH
<b>Order no.</b>	301995	301252 or 301254
<b>Type</b>	2 electrode	4 electrode
<b>Electrode material</b>	Graphite	Graphite
<b>Flow-through vessel</b>	-	Epoxy
<b>Shaft material</b>	Epoxy	-
<b>Shaft length</b>	120 mm	-
<b>Cell constant</b>	0.84 cm <sup>-1</sup>	0.778 cm <sup>-1</sup>
<b>Diameter</b>	15.3 mm	-
<b>Cable length</b>	1.5 m	-
<b>Measuring range</b>	1 µS/cm to 20 mS/cm	10 µS/cm to 1000 mS/cm
<b>Temperature range</b>	0 to 80 °C	0 to 60 °C
<b>Temperature probe</b>	NTC 30 kOhm	NTC 30 kOhm
<b>min./max. immersion depth</b>	36/120 mm	-

НеваРеактив

## Four-electrode conductivity cells



TetraCon® 325



TetraCon® S



TetraCon® 325/C

### Graphite measuring cells for universal use

- TetraCon® 325

Suitable for almost all conductivity measurements in aqueous samples; for outdoor use available with cable lengths up to 20 m.

### Graphite measuring cells for special applications

- TetraCon® 325 S

With shovel-shaped electrode holder, especially suitable for measuring in pasty samples.

### Graphite measuring cells for special applications

- TetraCon® 325/C

This measuring cell is designed for measurement in acidic samples.

### Flow-through measuring cells in the laboratory

- TetraCon® 325 DU

Four-electrode flow-through conductivity cell, (also with Hansen connector, DU / TH), for standard applications. Requires separate connection cable KKDU 325.



TetraCon® DU, DU/TH

НеваРеактив

Two-electrode conductivity cells with stainless steel and graphite electrodes



LR 325/01



LR 325/001



KLE 325

**Two electrodes ultra-pure water measuring cells**

- LR 325/01

Two electrode measuring cell with concentric stainless steel electrodes and glass flow-through vessel for measuring low conductivities up to 200  $\mu$ S/cm.

**Two electrodes pure-water measuring cells**

- LR 325/001

Two electrode measuring cell with concentric stainless steel electrodes and glass flow-through vessel for measuring trace conductivities up to 30  $\mu$ S/cm.

**Simple two electrode graphite LF measuring cell**

- KLE 325

Graphite-based two-electrode measuring cell for medium measuring ranges up to 20 mS/cm for simple applications, also in training and education.

# Calibration and test means



## Kit for pure water measurement according to pharmacopoeia

This kit includes LR 325/01 ultra-pure water cell, flow-through vessel D 01 / T made of glass (USP-KIT 1) or stainless steel (USP-KIT 2) NIST traceable 5  $\mu$ S standard with accuracy  $\pm$  2% and 6R/SET/Lab 1 test resistance set.

6R/SET/Lab 1 Test resistance set



Calibration standard 5  $\mu$ S/cm

## Calibration standard 100 $\mu$ S/cm

Shelf life 2 years, NIST traceable with accuracy  $\pm$ 3%

## Calibration standard 5 $\mu$ S/cm

Shelf life 1 year, NIST traceable with accuracy  $\pm$ 2%

## Order information: Calibration and test means

Model	Description	Order no.
<b>USP Kit 1</b>	Kit for conductivity measurement according to pharmacopoeia, consisting of: LR 325/01 Purest water cell, D 01/T flow-through vessel, NIST traceable 5 $\mu$ S/cm standard with accuracy $\pm$ 2% and 6R/SET/Lab 1 testing resistance set	300569
<b>USP Kit 2</b>	as USP Kit 1, but stainless steel flow-through vessel instead of D 01/T	300568
<b>Calibration means</b>		
<b>KS 100<math>\mu</math>S</b>	Calibration standard 100 $\mu$ S/cm, shelf life 2 years, NIST traceable with accuracy $\pm$ 3% (300 ml)	300578
<b>KS 5<math>\mu</math>S</b>	Calibration standard 5 $\mu$ S/cm, shelf life 1 year, NIST traceable with accuracy $\pm$ 2% (300 ml)	300580
<b>SET Trace</b>	Calibration set (6 bottles at 50 ml calibration and control standard, KCl 0.01 mol/l), NIST traceable with accuracy $\pm$ 0.5%	300572

For accessories & cables, see price list or [www.WTW.com/de](http://www.WTW.com/de)

# Flow-through vessels

With WTW conductivity cells, there are different possibilities to measure in the flow.

Ultra-pure water measuring cells are offered with a compatible measuring vessel, as impurities by introducing carbon dioxide must also be absolutely excluded.

For conductivity cells with a diameter of 12 mm, a flow-through measuring vessel is also available. For standard measuring cells with a diameter of 15.3 mm, there is the D 201, which ensures a trouble-free conductivity measurement.



Trace conductivity cell LR 325/001 with stainless steel flow-through vessel



Flow-through measuring cell for four pole conductivity cell

## Order information: Flow-through vessels

Model	Description	Order no.
D 201	Flow-through vessel of PMMA, internal diameter 18 mm, V*=13 ml (To TetraCon® 325)	203730
D 201/T	Flow-through vessel of glass, internal diameter 18 mm, V*=17 ml (Replacement measuring vessel for LR 325/01)	302750

For accessories & cables, see price list or [www.WTW.com](http://www.WTW.com)

V\* = Filling quantity without sensor



# BOD/Respiration



## Content

- 113 Applications and measuring systems
- 114 Dilution BOD as per DIN EN 1899-1
  - 114 inoLab® IDS - digital
  - 115 inoLab® - analog
  - 115 Sensors
- 116 BOD measurement and respirometric degradation methods with OxiTop®
  - 116 BOD self-check measurement with OxiTop® IS and OxiTop® Control according to DIN EN 1899-2
- 120 Degradation/respiration measurement with OxiTop® Control OC 110
- 121 Determination of the microbial soil respiration as per DIN ISO 16072
- 122 Determination of the biological degradability as per ISO 9408 / OECD 301 F
- 124 Biogas and microbiological determinations (aerobic/anaerobic measuring operation)
- 125 System expansions and general accessories for OxiTop® measuring systems

# Applications and measuring systems

BOD and degradability measurements are methods for determining the cleaning performance of microorganisms in aqueous solutions, and in semi-solid systems such as soil samples. The basis is the respiration of organically bound carbon to carbon dioxide. The pressure drop is recorded in closed vessels with the addition of a CO<sub>2</sub> absorber and the oxygen consumption is determined from the known volumes. In anaerobic methods, biogas is developed in the absence of oxygen. The yield of methane is determined via the resulting overpressure.

	Digital			Analogue	Respirometric systems					
	Oxygen benchtop meters									
	inoLab® IDS			inoLab®	OxiTop®	OxiTop® Control				
	Multi 9630	Multi 9620	Multi 9310	Oxi 7310	IS	6/12	B6, B6M, B6M 2.5	S6/S12, A6/A12	AN 6, AN 12	
✓ yes										
● yes										
✓ recommended										
✓ recommended for some applications										
– not recommended										
2 parameters simultaneously*	✓	✓								
3 parameters simultaneously	✓									
Dissolved oxygen optical	●	●	●							
Dissolved oxygen galvanic				●						
Pressure measurement					●	●	●	●	●	
Additional parameters	●	●	●							
LIMS connection	✓	✓	✓	✓			✓	✓	✓	
PC connection	✓	✓	✓	✓			✓	✓	✓	
Memory	✓	✓	✓	✓			✓	✓	✓	
USB interface	✓	✓	✓	✓						
Graphic display			✓	✓			✓	✓	✓	
Color graphic display	✓	✓								
Optical dissolved oxygen sensor	✓	✓	✓							
Conventional dissolved oxygen sensors				✓						
Self-stirring dissolved oxygen sensor				✓						
Manual read out					✓	✓				
Read out via IR controller						✓	✓	✓	✓	
BOD Routine					✓	✓				
BOD Standard						✓				
BOD Special							✓	✓	✓	
Output pressure							✓	✓	✓	
BOD measurement					✓	✓		✓	✓	
Soil respiration							✓			
Aerobic degradation						✓		✓		
Anaerobic degradation									✓	
Compatible sensors										
Digital IDS dissolved oxygen sensor										
IDS Optical dissolved oxygen sensor	33	✓	✓	✓						
Analogue dissolved oxygen sensors										
Galvanic dissolved oxygen sensors	92			✓						
Self-stirring dissolved oxygen sensors	93			✓						
		Multi 9630	Multi 9620	Multi 9310	Oxi 7310	IS	6/12	B6, B6M, B6M 2.5	S6/S12, A6/A12	AN 6, AN 12
	see page	40	40	41	88	117	118	121	123	124

# Dilution BOD according to DIN EN 1899-1

## inoLab® IDS - digital



BOD measurement with the new digital multi-parameter meters inoLab® IDS:

### inoLab® Multi 9630 IDS: Measure three parameters simultaneously

The digital inoLab® multi-parameter instrument for IDS sensors for parallel measurement of up to three parameters. The FDO® 925 optical dissolved oxygen sensor is compatible with the inoLab® Multi 9630 and approved for BOD measurement



inoLab® Multi 9630 IDS

see page 40

### inoLab® Multi 9620 IDS: Measure two parameters simultaneously

Similar to the inoLab® Multi 9630 IDS, but up to two sensors can be connected.



inoLab® Multi 9620 IDS

see page 40

### inoLab® Multi 9310 IDS: Digital single parameter solution

The new inoLab® Multi 9310 IDS is well suited for dissolved oxygen measurement in the laboratory. The IDS technology allows optimized measurements and efficient documentation in the simplest manner.



inoLab® Multi 9310 IDS

see page 41

## Order information: Dilution BOD

Model	Description	Order no.
inoLab® Multi 9310 SET 4	Digital multi-parameter benchtop meter with a universal measuring channel for pH/mV, dissolved oxygen and conductivity. Meter in a set of optical IDS dissolved dissolved oxygen sensor FDO® 925, accessories	1FD354
inoLab® Oxi 7310 SET 4	Professional, menu-controlled dissolved oxygen benchtop meters in a set with self-stirring dissolved oxygen sensor StirrOx® G, accessories	1BA304

For additional products, see price list or [www.WTW.com](http://www.WTW.com)

# inoLab® - analogue



All benchtop meters are available in application-oriented sets with sensors and accessories.

## inoLab® Oxi 7310: Reliable measurement of dissolved oxygen with documentation

The inoLab® pH 7310 is perfectly suited for precision measurement and automatic GLP/AQA compliant documentation in quality laboratories of all industries. The meter is equipped a special connector for the connection of the StirrOx® G self-stirring dissolved oxygen sensor. Also available with optional built-in printer.

see page 88



inoLab® Oxi 7310P  
(with built-in printer)

## Sensors

### FDO® 925(-P): Optical dissolved oxygen sensor

Flexible and powerful optical dissolved oxygen sensor also for IDS meters for BOD measurement

- Calibration free through factory calibration
- Wireless module makes it well suited for BOD measurement
- Attachment stirrer for BOD measurement

see page 33



FDO® 925

### StirrOx® G: Galvanic dissolved oxygen sensor

Self-stirring galvanic dissolved oxygen sensor for measurement in Karlsruher and Winkler bottles

- One-hand operation for quick series measurement
- Constant flow for high reproducibility
- Extremely low intrinsic oxygen consumption - only  $0.008 \mu\text{g h}^{-1} (\text{mg/l})^{-1}$
- Membrane leakage monitoring
- Long lifetime up to 6 months

see page 93

Technical data see dissolved oxygen sensors



StirrOx® G

# BOD measurement and respirometric degradation methods with OxiTop®

## BOD self-check measurement with OxiTop® IS and OxiTop® Control according to DIN EN 1899-2

OxiTop® provides an easy and safe way to measure biochemical oxygen requirement in water and wastewater analysis. Both systems work mercury-free and without dilution series. Complete sets including measuring heads, bottles and necessary accessories are ready to use. In all aerobic degradation measurements, the measuring principle is based on the absorption of the carbon dioxide resulting by microbial metabolism through suitable absorbers and thus the pressure drop resulting in a closed vessel. This is recorded and used for the calculation.



The OxiTop® BOD measurement system is particularly suited for wastewater analysis.

	OxiTop® IS 6/IS 12	OxiTop® Control 100	OxiTop® Control 110
<b>Application</b>	BOD Routine	BOD Routine BOD Standard	BOD Routine BOD Standard BOD Special Aerobic and anaerobic respiration test
<b>Measuring range BOD</b>	0 - 4000 mg/l	0 - 4000 mg/l	0 - 400,000 mg/l
<b>Measurement value memory</b>	5 days	0.5 h - 99 days	0.5 h - 99 days
<b>Pressure mode</b>	-	-	500 - 1350 hPa
<b>Sample volume</b>	Fixed specifications	Fixed specifications	Freely selectable

## OxiTop® IS 6/IS 12

- **Simple operation without dilution series**
- **Data security through Measured parameter memory**
- **Coordinated set for immediate measurement**



OxiTop® IS 12

Easy to operate respirometric measuring system for BOD<sub>5</sub>. The sets include 6 or 12 measuring units. The heads in green or yellow mark inlet or outlet measurement. The AutoTemp function ensures a correct sample start at sample temperatures between 15 and 21 °C. Inductive, wear-free operating stirring platforms with pre-programmed stirring characteristics ensure optimum mixing of the sample. The data can be entered in a prepared diagram and give an immediate overview of the course of the measurement.

### Technical specifications: OxiTop® Measuring head

	Technical specifications
<b>Measurement principle</b>	Manometric with pressure sensor
<b>Measured parameter</b>	BOD <sub>n</sub>
<b>Measuring range</b>	0 ... 40 digit (display units) corresponds to 0 ... 40 / 80 / 200 / 400 / 800 / 2000 / 4000 mg/l BOD
<b>Display accuracy</b>	±1 (± 3.55 hPa)
<b>Pressure range</b>	500 - 1100 hPa
<b>Memory</b>	For BOD <sub>5</sub> : 1 per day
<b>Ambient temperature</b>	Storage: -25 °C ... +65 °C Operation: +5 °C ... +50 °C
<b>Dimensions</b>	H: 69 mm, Ø 70 mm

### Order information: OxiTop® IS6/IS12

Model	Description	Order no.
OxiTop® IS 6	BOD measuring system for self-check measurement with 6 measuring units including accessories, universal power supply, 100 - 240 VAC, 50/60 Hz	208210
OxiTop® IS 12	BOD measuring system for self-check measurement with 12 measuring units including accessories, universal power supply, 100 - 240 VAC, 50/60 Hz	208211

For further products, see price list or [www.WTW.com](http://www.WTW.com)

## OxiTop® Control 6/Control 12 System

- **Convenient and easy operation by the controller**
- **Suitable for large sample volumes - Up to 100 parallel samples**
- **Time-saving and error-avoiding with automatic statistical evaluation**
- **Easy assignment through automatic sample ID**

The OxiTop® Control System is perfect for processing large BOD samples. With the infrared interfaces, the OC 100 controller communicates with up to 100 measuring heads. OxiTop®-C measuring heads record up to 360 data points over the measurement period, and thus provide a complete representation of the measurement. The curve representation is also possible on the controller display. The controller provides both routine and standard measurements with statistical calculations. The sets contain all necessary parts for immediate measurement. The controller OC 110 is available for further examinations. Available with 6 or 12 measuring units.



OxiTop® Box with OxiTop® Control 12

## Application areas and technical specifications: OxiTop® Controller

	OxiTop® Control OC 100	OxiTop® Control OC 110
<b>BOD Routine</b>	Individual samples up to 4000 mg/l	Individual samples up to 4000 mg/l
<b>BOD Standard</b>	Parallel samples with statistical evaluation up to 4000 mg/l	Parallel samples with statistical evaluation up to 4000 mg/l
<b>BOD Special</b>	–	Freely definable volumes, 0.5 h - 99 days, up to 400,000 mg/l BOD
<b>Soil respiration</b>	–	free volume determination
<b>OECD/Aerobic application</b>	–	free volume determination
<b>Biogas determination</b>	–	Pressure mode p 500 - 1350 hPa; 10 intermediate values
<b>Data sets per measurement</b>	180 ... 360 (depending on runtime)	180 ... 360 (depending on runtime)
<b>Runtime of the measurement</b>	0.5 hours ... 99 days	0.5 hours ... 99 days
<b>Power supply</b>	3 Mignon (type AA); alkaline 1.5 V	3 Mignon (type AA); alkaline 1.5 V
<b>Interface</b>	IR (Infrared); RS 232 for PC communication	IR (Infrared); RS 232 for PC communication
<b>Ambient temperature</b>	Storage: -25 °C ... +65 °C, operation: +5 °C ... +40 °C	Storage: -25 °C ... +65 °C, operation: +5 °C ... +40 °C
<b>Dimensions</b>	45 x 100 x 200 mm (H x W x D)	45 x 100 x 200 mm (H x W x D)
<b>Weight</b>	approx. 390 g	approx. 390 g

## Technical specifications: OxiTop®-C and OxiTop -C/B measuring heads

<b>Measurement principle</b>	manometric with pressure sensor
<b>Measured parameter</b>	BOD <sub>n</sub> (theoretically for up to 99 days)
<b>Pressure range</b>	500 - 1350 hPa
<b>Accuracy</b>	±1 % of measured parameter ±1 hPa
<b>Resolution</b>	1 hPa (corresponds to 0,7 % of the BOD <sub>n</sub> measuring range)
<b>Power supply</b>	2 x CR2430 Lithium battery (280 mAh)
<b>Ambient temperature</b>	Storage: -25 °C ... +65 °C Operation: +5 °C ... +50 °C
<b>Dimensions</b>	H: 70 mm, Ø 70 mm

## OxiTop® Controller OC 100/OC110

- Convenient sample management and grouping of up to 100 OxiTop®-C measuring heads
- On request sample statistics or individual measurement
- Automatic BOD calculation and curve representation for optimal measuring control
- Readout possibility via PC program Achat OC for processing in spreadsheet programs
- BOD special mode with free temperature and volume selection and pressure mode (OC 110 only)
- Measuring intervals between 0.5 h and 99 days



1 year warranty CE

OxiTop® OC 100

## OxiTop®-C and -C/B: Measuring heads for standard and biogas applications

- Infrared communication between OxiTop®-C and controller OC 100 or OC 110 for programming and data acquisition
- Automatic assignment of a sample ID for unambiguous identification and statistical evaluation
- AutoTemp function for correct measuring start at sample temperatures between 15 and 21 °C
- Up to 360 measuring units per measuring cycle for precise determination of the measuring process
- OxiTop® C/B: through H<sub>2</sub>S-resistant pressure sensor particularly suitable for biogas applications



OxiTop®-C/B



OxiTop®-C

1 year warranty CE



OxiTop® Control 12

## Order information: OxiTop controller and measuring heads

Model	Description	Order no.
OxiTop® OC 110	OxiTop® controller OC 110 for controlling BOD and special applications of OxiTop®-Control measuring systems	208207
OxiTop®-C	OxiTop®-C replacement measuring head (can only be used in conjunction with OxiTop® controller OC 100 / OC 110)	208830
OxiTop®-C/B	OxiTop®-C / B replacement measuring head (can only be used in conjunction with OxiTop® controller OC 100/OC 110. Corrosion-resistant version for anaerobic / biogas applications)	208831

For additional products, see price list or [www.WTW.com](http://www.WTW.com)



# Degradation/respiration measurement with OxiTop® Control OC 110

For environmental tasks, such as wastewater treatment, soil decontamination and waste treatment, the examination and monitoring of biological treatment processes is of great importance.

In addition to the usual physical-chemical measuring methods, biological tests are in the foreground. To determine the biological degradability of nutrients, contaminants, pollutants or waste materials by means of microbial activity, respiration measurements (i.e. degradation measurements) are carried out. In these, the respiration of the organisms, measured as oxygen uptake or as carbon dioxide release, is determined under defined conditions.

The measurements take place via closed systems with OxiTop®-C and the controller OC 110. Depending on the application area, correspondingly optimised measuring vessels are used, all of which have the necessary connection threads for the measuring head and are partially autoclavable. Various complete packages with all necessary utensils are available for this.



OxiTop® Controller

	Application and method	Measurement principle
<b>Measurement of soil respiration</b> Page 121	Soil analysis, remedial action of contaminated sites, DIN ISO 16072, AT4	Aerobic under CO <sub>2</sub> absorption, also quantitative CO <sub>2</sub> determination
<b>Measurement of biological degradability</b> Page 122	Determination per OECD 301F, ISO 9408	Aerobic under CO <sub>2</sub> absorption
<b>Biogas measurement</b> Page 124	Anaerobic degradability tests (e.g., VDI 4630, GB 21)	Anaerobic, determination CO <sub>2</sub> , methane; warning pressure possible
<b>Biological measurement</b> Page 124	Growth and stress tests, determination of the respiration rate	Aerobic; warning pressure possible

# Measurement of microbial soil respiration per DIN ISO 16072

- **Various vessels for optimal adaptation to the application**
- **Measurements up to 99 days for special applications**
- **Also suitable for AT4 measurement**

Soil respiration measurement serves for the prognosis, survey and control of remedial action, for biochemical degradation measurements of pesticides, fungicides, insecticides, fertilizers, etc., as well as for performing toxicity tests.

For soils with greater CO<sub>2</sub> development, the measuring vessel MG 1.0 is available, through whose large opening (diameter approx. 100 mm) large-volume CO<sub>2</sub>absorber vessels fit.

To measure the respiration of the AT4 guideline of residues of biomechanical waste treatment, a special kit is available containing 2.5 liter measuring vessels and a special CO<sub>2</sub>-absorber with indicator.

## OxiTop® Control B6

Set for general application with soils with low and medium respiratory activity, consisting of 6 bottles with GL 45 thread and 500 ml volume. Including 6 OxiTop®-C measuring heads and controller OC 110.



OxiTop® Control B6M

## OxiTop® Control B6M

Set for respiratory active soils with six 1 litre vessels. The vessels feature large openings for convenient sample preparation.

## OxiTop® Control B6M-2.5

Special set for the determination of respiration according to the AT4 guideline. The set features 2.5 l vessels and special soda lime absorber to ensure the moisture content of the sample. Including 6 OxiTop®-C measuring heads, controller OC 110 and accessories.



OxiTop® Control B6M 2.5

## Order information soil respiration

Model	Description	Order no.
OxiTop® Control B 6M-2.5	Measuring systems for determining AT4 soil respiration (aerobic), with controller OC 110 and 6 measuring units with 2.5 l measuring vessels.	208231
OxiTop® Control B 6M	Measuring system for determining the soil respiration (aerobic) with controller OC 110 and 6 measuring units;	208232

For additional products, see price list or [www.WTW.com](http://www.WTW.com)

# Measurement of biological degradability per ISO 9408 / OECD 301 F

- **Easy handling for safe results**
- **Flexible use for different volumes and temperatures**
- **Graphical evaluation in the controller for process monitoring**

OxiTop® Control measuring system for determining biodegradability per DIN EN ISO 9408 / OECD 301 F.

The determination of the biological degradability must be ensured before the first use of "new" chemicals; not only for environmental reasons, but also to minimise disposal costs.

The prepared sample and a blank are stirred for 28 days at a constant temperature in a closed bottle.

The resulting CO<sub>2</sub> is removed from the gas chamber by means of an absorber, so that the resulting underpressure represents a measure for the biological degradability.

Due to the continuous recording of the measured parameters in the OxiTop®-C, the required documentation is fully guaranteed. The measuring bottles and the adapter are autoclavable at 121 °C.

There are a total of four sets available for this application, which are adapted to different tasks.



OxiTop® Box  
OxiTop® Control A6

## OxiTop® Control A6

Set with six 1 liter wide-neck bottles and autoclavable adapter AD/SK, including controller OC 110 and stirring platform IS-6-Var. For example for samples that require high dilution.

## OxiTop® Control A12

Set with twelve 250 ml wide-neck bottles and autoclavable adapter AD/SK, including controller OC 110 and stirring platform IS 12.

## OxiTop® Control S6

Set of six 510 ml sample bottles PF 600 including controller OC 110 and stirring platform IS 6. Well suited for samples where there is a risk of algae growth

## OxiTop® Control S12

Set with twelve 510 ml sample bottles PF 600 including controller OC 110 and stirring platform IS 12. Well suited for samples where there is a risk of algae growth



OxiTop® Control A6



OxiTop® Control IS6

## Order information: Systems for determining the aerobic degradability

Model	Description	Order no.
OxiTop® Control S 6	BOD measuring system for aerobic measuring operation, with controller OC 110 and 6 measuring units, (also for BOD self-check)	208196
OxiTop® Control A 6	BOD measuring system for aerobic measuring operation, with controller OC 110 and 6 measuring units.	208220

For additional products, see price list or [www.WTW.com](http://www.WTW.com)

# Biogas and microbiological determinations (aerobic/anaerobic measuring operation)

- **Convenient and accurate measurement of the biogas rate**
- **Targeted manipulation possible with special measuring bottles**
- **Safety through warning pressure function**

A major application is the verification of fermentable substrates for biogas plants for the estimation of gas yield. Anaerobic degradation processes take place under exclusion of oxygen. So that the gas space above the sample can be filled with inert gas, the measuring bottle has lateral connection pieces. These are closed with septa, so that carbon dioxide can be withdrawn at the end of the trial by adding a CO<sub>2</sub>-absorber. The resulting pressure difference is proportional to the CO<sub>2</sub>-concentration, the remaining overpressure is proportional to the methane concentration.

The degradation process can be conveniently tracked with the "pressure" operating mode. Since the production of methane gas under anaerobic processes leads to an increase in pressure, it can happen that the measuring range can be exceeded. For these cases, it is possible to specify a "warning pressure" or pressure limit value, so that the user can manipulate the system.

## OxiTop® Control AN6

Set of six 1 l bottles with nozzles and autoclavable adapter AD/SK, including six corrosion-resistant special measuring heads OxiTop® C/B, controller OC 110 and stirring platform IS-6-Var as well as additional accessories. For anaerobic and aerobic measurements.



OxiTop® Control AN 6

## OxiTop® Control AN12

Set of six 250 ml bottles with nozzles and autoclavable adapter AD/SK, including twelve corrosion-resistant special measuring heads OxiTop® C/B, controller OC 110 and stirring platform IS 12 as well as accessories. For anaerobic and aerobic measurements.

## Order information: OxiTop® Control systems

Model	Description	Order no.
OxiTop® Control AN 6	BOD measuring system for anaerobic measuring operation, with 6 measuring units and controller OC 110,	208225
OxiTop® Control AN 12	BOD measuring system for aerobic measuring operation, with 12 measuring units and controller OC 110,	208227

For additional products, see price list or [www.WTW.com](http://www.WTW.com)

# System extensions and accessories for OxiTop® measuring systems

System extensions and accessories are available to meet additional needs, including:

- Individual measuring heads OxiTop®, OxiTop®-C and OxiTop®-C/B
- Sets of OxiTop®- and OxiTop®-C measuring heads
- Complete measuring units expansion sets including heads, stirring platforms and accessories
- Stirring platforms
- Sample bottles and vessels

## Stirring platforms for all liquid samples

The inductive maintenance and wear-free stirring platforms IS 6 and IS 12 are specially optimised for BOD measurement and have 6 or 12 stirring locations respectively. A program-controlled stirring process ensures optimum mixing between the liquid and the gas phase and prevents that the stirring bar is getting caught. With the IS 6-Var platform, stirring in large vessels is also possible, and there are two speed levels.



Stirring platforms IS 6 and IS 12



## OxiTop® system function testers

The test for functionality of OxiTop® measuring heads and systems can be carried out with two test equipment, when using controllers even in defined intervals.

### OxiTop® PT

With the OxiTop® PT, single heads are tested for tightness and correct function in a simple test. For this, an under pressured is simulated, which is tabulated accordingly. The default values are automatically stored in the controller of the OxiTop®-C.



Test means PT and PM

### OxiTop® PM

These special calibration tablets simulate a BOD of approx. 300 mg/l (batch-dependent). Thus, complete measuring systems can be tested for the function of the measuring heads or the tightness.

## Further accessories



Storage rack and marking rings



Overflow flasks

### Storage rack

Safe storage of up to 6 OxiTop® or OxiTop®-C measuring heads

### Marking rings

Labelling and identification of the BOD bottles

### Overflow flasks

In addition to the standard measuring bottles, 164 ml and 432 ml available in the set. Further volumes are available including: 22.7 ml, 43.5 ml, 97 ml, 250 ml and 365 ml.

## Incubator OxiTop® Box

- Space saving and compact
- Air circulation cooling for uniform temperature distribution
- Automatically preset to 20 °C

Thermo boxes for incubating BOD samples (dilution samples or respirometric samples) at constant temperature for easy requirements

Thermostat box with air circulation cooling for BOD OxiTop® measuring systems with a maximum of 12 measuring units or 20 Karlsruher bottles for easy requirements. Comes factory set to 20 °C. Low maintenance with automatic condensate evaporation.



OxiTop® Box

18 months warranty



The OxiTop® Control allows to read out the measured values without opening the incubator box.



## Technical specifications: OxiTop® Box

Model	OxiTop® Box
Temperature control	20 °C ±0,5 °C
Ambient temperature	Storage: -25 °C ... +50 °C Operation: +10 °C ... +32 °C
Power input	200 W
Dimensions (H x W x D)	375 x 425 x 600 mm
Weight	Approx. 30 kg

## Order information: OxiTop® Box

Model	Description	Order no.
OxiTop® Box	BOD OxiTop® thermostat box with temperature-controlled air circulation, for mains operation 230 V/50 Hz	208432
For the 60 Hz version, see price list or www.WTW.com		



## Thermostat cabinets TS

- **Cost-effective solution for respirometric test procedures**
- **Models with glass doors for OxiTop® Control applications**
- **Energy-efficient thermal insulation**

Thermostat cabinets for the incubation of respirometric samples at constant temperatures between 10 and 40 °C - cost-effective and energy-efficient.

WTW Thermostat cabinets are adapted to respirometric measurements with OxiTop® systems. The temperature can be set in increments of 1 °C, which is maintained within ± 0.5 °C. The thermal insert with the radial fan for the constant temperature control has sockets for the agitating platforms. The thermo cabinets are available in three sizes.

### Technical specifications: Thermostat cabinets

Model	TS 606/2-i	TS 606/4-i	TS 1006-i
Shelves	2	4	4 with further distance
Number of samples	2 x 12 BOD Standard	4 x 12 BOD Standard	4 x 12 BOD standard 4 x 6 Special vessels
Glass door	Optional	Optional	–
Temperature control range	+10 °C ... +40 °C ±1 °C; setting interval: 1 °C		
Ambient temperature	Operation: +10 °C ... +32 °C (climate class SN); storage: -25 °C ... +65 °C		
Gross content	180 l	360 l	500 l
Dimensions (H x B x T in mm)	Outside: 850 x 600 x 600 Inside: 702 x 513 x 441	1640 x 600 x 610 1452 x 470 x 440	1640 x 750 x 730 1452 x 600 x 560
Weight	34 kg	53 kg	69 kg

### TS 606/2-i and TS 606-G/2i

Thermostat cabinet for two OxiTop® measurement systems with maximally twelve measuring stations each. For 230 VAC, 50 Hz.

The model TS 606-G/2i has a door with insulated glass for OxiTop®-C operation.



TS 606-G/2-i





TS 606/4-i

## TS 606/4-i and TS 606-G/4i

Thermostat cabinet for four OxiTop® measurement systems with a maximum of twelve measuring units each. For 230 VAC, 50 Hz.

The model TS 606-G/4i has a door with insulated glass for OxiTop®-C operation.

## TS 1006-i

Thermostat cabinet for four OxiTop® measurement systems with maximally twelve measuring units each. Also suitable for special applications due to the high compartment height. For 230 VAC, 50 Hz.



## Order information: Thermostat cabinets

Model	Description	Order no.
TS 606/2-i	Thermostat cabinet for 2 BOD-OxiTop® measurement systems	208380
TS 606/4-i	Thermostat cabinet for 4 BOD-OxiTop® measurement systems	208383
TS 1006-i	Thermostat cabinet for 4 BOD-OxiTop® measurement systems	208385
606-G/2-i	Thermostat cabinet for 2 BOD Oxitop® measurement systems with glass door	208381
606-G/4-i	Thermostat cabinet for 4 BOD Oxitop® measurement systems with glass door	208384

Additional accessories see price list or [www.WTW.com](http://www.WTW.com)

# Photometric determination



---

## Contents

- 131 Applications and meter overview
  - 132 Routine and spectral analysis
  - 133 The pHotoFlex®, photoLab® and photoLab® 7000 Series
    - 134 photoLab®7000 spectrophotometer
    - 141 photoLab® S6 and S12
    - 143 pHotoFlex®
  - 148 Thermoreactors
  - 150 Reagents and optical reagent-free methods
  - 160 Testing equipment
  - 162 General instructions
  - 162 Reagent-free tests
-

# Applications and meter overview

Photometric determination is an important measurement procedure for routine analysis in water, production industry, and in environmental monitoring. But also, for special measurement tasks and quality control in industry, development, research and education.

● yes

✓ recommended

✓ recommended for some applications

– not recommended/not present

	Laboratory photometer				Portable photometer		
	photoLab® 7100 VIS	photoLab® 7600 UV-VIS	photoLab® S6	photoLab® S12	pHotoFlex® STD	pHotoFlex® pH	pHotoFlex® Turb
Photometric determinations	●	●	●	●	●	●	●
Electrochemical pH/ORP measurement						●	●
Turbidity measurement as per DIN JSO							●
Reagent-free COD, nitrate, nitrite		●					
Spectrophotometer (_adjustable wave lengths)	✓	✓					
Filter photometer			✓	✓			
LED + optical filter					✓	✓	✓
6 wavelengths			✓		✓	✓	✓
12 wavelengths				✓			
IR-LED							✓
Programs for test kits	✓	✓	✓	✓	✓	✓	✓
Round cells 16/28	✓/-	✓/-	✓/-	✓/-	✓/✓	✓/✓	✓/✓
Rectangular cuvettes 10, 20, 50 mm	✓	✓		✓			
AQA support	✓	✓	✓	✓	✓	✓	✓
Barcode support	✓	✓	✓	✓	optional	optional	optional
Sample ident. Number	✓	✓	✓	✓	✓	✓	✓
Special methods NH <sub>3</sub> , CO <sub>2</sub>	✓	✓				✓	✓
Reagent-free data base correction: Reagent-free (reagent-free COD, nitrate, nitrite)		✓					
User-defined programs	✓	✓		✓	✓	✓	✓
Comprehensive programming	✓	✓					
Multi-wavelength measurement/scans	✓	✓					
Color measurement, PC-based	✓	✓					
Coloration	✓	✓	✓	✓	✓	✓	✓
Kinetics	✓	✓		✓			
pH/ORP/Turb					-/-	✓/✓/-	✓/✓/✓
PC software data management + LIMS connection	✓	✓			✓	✓	✓
PC interface USB / Ethernet / RS232	✓/✓/-	✓/✓/-	-/-/✓	-/-/✓	-/-/✓	-/-/✓	-/-/✓
Battery/rechargeable battery	-/-	-/-	-/✓	-/✓	✓/-	✓/optional	✓/optional
Car battery adapter for off-line use	✓	✓					
Field case set/field case	-/✓	-/✓			✓/✓	✓/✓	✓/✓
	see page	138	139	141	141	144	145

	Thermoreactors		
	CR 2200	CR 3200	CR 4200
Routine analysis	✓	✓	✓
Routine programs for wastewater/electroplating	✓	✓	✓
User-defined programs up to 170°C		✓	✓
Two parallel digestion programs in parallel			✓
AQA		✓	✓

# Systematic and spectral analysis – routine measurement and photometric investigation

Photometric determinations can be divided into two large groups.

The **routine measurement** of measuring parameters in water analysis, also known as systematic analysis, facilitates a simple and quickly readable measurement with minimum effort using commercial test kits and the associated method data in the photometer. Thus, the analyte to be measured is transformed to a measurable colorant with the relevant reagents. The coloration results from the absorption of particular light components (wavelengths) from white light. Measurements are usually taken at the wavelength with the highest absorption.

Such routine measurements are standard tasks in water analysis of wastewater, drinking water or environmental monitoring.

Photometers and optimized test kits for various measurement ranges form a system, which is harmonized. Method data and programs as well as measuring ranges for the respective test kits are not identical in different photometer models due to the optical variations such as light sources.

**Spectral analysis** is particularly useful for studies of unknown substances, methods development and for optimizing testing systems: In order to, for example, determine the maximum absorption and thus the suitable wavelength for test systems, spectra are taken over a wider wavelength range. Thus, the highest peak and most suitable absorption is detected. In addition there are investigations such as enzyme kinetics or multi-wavelength measurements. A further aspect is color measurement for the product quality analysis and assurance.

## What do all of the series offer?

- **Proven quality**
- **Intuitive operation**
- **The highest precision**

Three classes of photometric instruments for different applications:  
pHotoFlex® series portable LED photometers (left)  
photoLab® S series filter photometers (bottom right)  
photoLab® 7000 series spectrophotometers (top right)



# Portable and precise: the pHotoFlex<sup>®</sup>, photoLab<sup>®</sup> and photoLab<sup>®</sup> 7000 Series

Mobile measurement with the pHotoFlex <sup>®</sup> Series	Lab Measurement with photoLab <sup>®</sup> S6/S12 and the photoLab <sup>®</sup> 7000 Series
<p>Measurement in changing locations is the focus. The meters are:</p> <ul style="list-style-type: none"> <li>energy-efficient</li> <li>robust</li> <li>portable</li> <li>precise</li> </ul> <p>These requirements are backed up by special optics with a combination of LED and filters. The robustness of the portable pHotoFlex<sup>®</sup> meters is based on the low warm-up and long lifetime of LEDs used. With two cuvette sizes, the largest possible measurement ranges and the use of most common test kits are made possible using the LabStation and LSdata PC software for comfortable data management.</p>	<p>Highest standards are required in the laboratory as basis of research, routine measurements and to ensure effluent compliance. To meet these needs, the instruments offer:</p> <ul style="list-style-type: none"> <li>AQA/IQC</li> <li>precise measurement</li> <li>wide measurement ranges</li> <li>convenience features, such as test and cuvette recognition.</li> <li>The reference beam optics and stable laboratory temperatures enable full pre-settings with higher work comfort.</li> </ul> <p>Additional features of the photoLab<sup>®</sup> 7000 Series:</p> <ul style="list-style-type: none"> <li>Testing from 190 - 1100 nm</li> <li>Reagent-free measurement of COD, nitrate and nitrite</li> <li>AQA and user administration</li> <li>Spectra, kinetics and multi-wavelength readings</li> <li>Data transfer via USB, even in large user environments</li> </ul>

## Photometer applications

	Portable photometers			Filter photometer		Spectrophotometers	
	pHotoFlex <sup>®</sup>			photoLab <sup>®</sup>			
	STD	pH	Turb	S6	S12	7100 UV	7600 UV-VIS
Applications / Application fields	Environmental monitoring, water analysis	Environmental monitoring, water analysis, drinks industry, wine industry, process monitoring, areas with different measurement tasks (photometry, pH, turbidity)		Routine measurements in waste and drinking water, field use optional	Routine measurements in waste and drinking water, wide-ranging laboratory testing tasks, field use optional	Spectral and special analyses in industry, teaching and research, and all analyses of routine measurements with standard parameters in waste and drinking water, as well as environmental analysis, on-site use	
Wavelengths	436, 517, 557, 594, 610, 690 nm	436, 517, 557, 594, 610, 690 nm	436, 517, 557, 594, 610, 690 nm, 860 nm (IR)	340, 445, 525, 550, 605, 690 nm	340, 410, 445, 500, 525, 550, 565, 605, 620, 665, 690, 820 nm	320 nm - 1100 nm (VIS), fully adjustable	190 nm - 1100 nm (UV-VIS), fully adjustable
Optical system	LED with filter	LED with filter	LED with filter	Filter/reference beam		Monochromator/beam-in + AutoCheck	
Special functions	–	pH/ORP	pH/ORP, turbidity	–	Kinetics	Absorption spectra, kinetics, multiple wavelength measurement, environmental parameters, routine and special measurements with AQA support, PC software photoLab <sup>®</sup> spectral data	
Measurement sets	100	1000	1000				
Measurement methods	50	100	1000	no	50	1000, 20 profiles	
Cuvettes	Round: 16 mm (variable height: 91 - 104 mm), 28 mm			Round 16 mm	Round and rectangular 10, 20, 50 mm		

# The photoLab®7000 Spectrophotometers All in one, one for all!

WTW spectrophotometers offer a unique combination in this instruments class of systematic and spectral analysis functions with the revolutionary reagent-free OptRF measurement for COD, nitrate and nitrite. They can be used for a wide variety of applications, from water analysis to the wine industry to science and teaching.

The quality reference beam optics ensures the greatest precision and is supported by comprehensive user management for the highest level of data security.

Thanks to the self-explanatory menu, the user can intuitively and quickly achieve the desired result:

- Bright color screen for a clear view of work processes with color-marked additional information and visual evaluations.
- Direct function call-ups via function keys F1 to F4 for standard functions such as menu-related settings, dilution, unit, etc.
- Search masks for the simplest selection of parameters, methods, etc.
- Reliable and robust tactile keypad
- Filter data for specific measurement datasets
- Input screens for user-defined methods and complex programming
- USB and Ethernet connection for data processing: Update, printing to PDFs and printers, saving and data export with LIMS connection

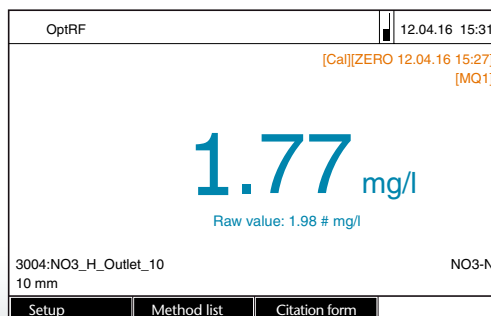
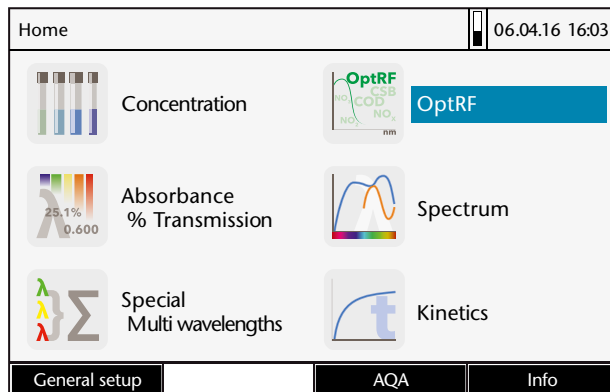

## Systematic analysis - routine measurement of standard parameters

The photoLab® 7000 Series offers proven and innovative functionalities for routine measurements in water analysis as well as standard laboratory tasks.

- Round *and* rectangular cuvettes with barcode recognition for large measurement ranges
- Automatic cuvette recognition with automatic measurement range selection
- More than 250 methods for commercial test kits
- Direct methods such as SAC, UVT, coloring
- Color measurement as per APHA 2120F
- Application packets and methods such as chlorophyll, brewing trade, etc.
- Custom routine methods
- OptRF: Unique optical reagent-free measurement of COD, nitrate and nitrite with photoLab® 7600

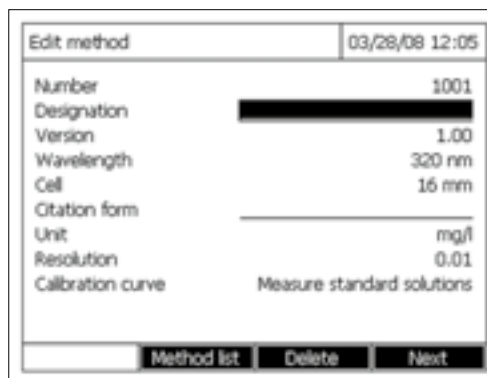
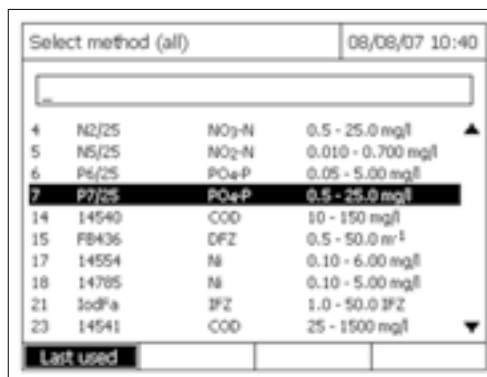

## Spectral analysis - from spectra to kinetics to programming

The photoLab® 7000 Series facilitates comprehensive laboratory analysis from water to research and teaching, even when on the go:

- Optical reagent-free measurement (OptRF) of COD, nitrate and nitrite via spectral measurement with evaluation between 200 and 390 nm,
- Kinetics with maximum or freely adjustable measurement count, time intervals and start delay.
- Spectra with custom definable wavelength range
- Multiple wavelength measurements
- Special tasks/form inputs for comprehensive measurement processes
- 20 profiles and 6 colors can be saved

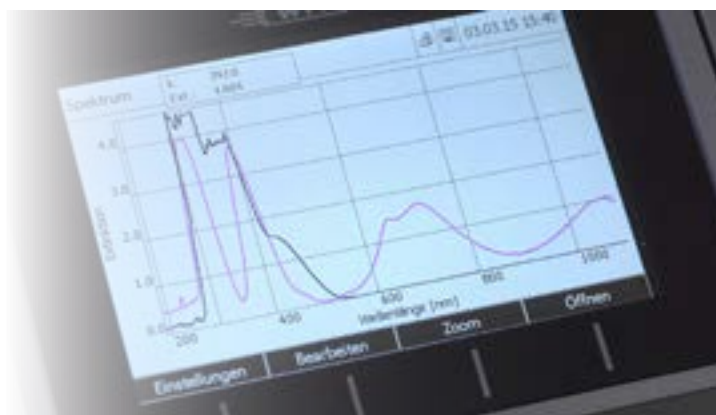



## Analytic quality assurance – for result security

Analytic quality assurance (AQA) has become a must for all branches of industry to ensure and document plausible and correct measurement results.

The photoLab® 7000 Series enables AQA with monitoring of the photometer and measurements. AQA can be switched on and off as desired and offers a monitoring function through:

- Administrator, user and guest rights
- Adjustable inspection intervals for Photometer and test kits
- PhotoCheck: Photometer check incl. check for linearity (3 wavelengths at 4 measurement points)
- Selection for gray filter and test standards
- Standards for individual parameters and CombiChecks
- Matrix check with pile-up



AQA2 setup		08/16/07 18:25
General		
Mode	Measurements	
Lock methods	Yes	
Method	6: P6/25	
AQA2	AQA2 inactive	
Interval	50 Measurements	
Target value	0.80 mg/l PO <sub>4</sub> -P	
Tolerance	0.08 mg/l PO <sub>4</sub> -P	
Standard ID		
Method		Apply

- Comprehensive test equipment
- MatrixCheck documentation
- User management

## IQ LabLink – the connection to the IQ SENSOR NET process monitoring system

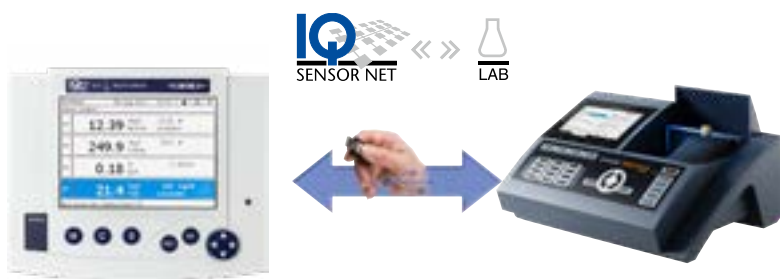

IQ-LabLink				08/21/08 11:51
Job number:	850	Date:	08/21/08	
Sensor type:	PHICOM+730Q	Serial number:	0468001	
Sensor name:	0468001	Photometer:	photoLab 6180 VCS	
User:	admin	Serial number:	07448001	
		Date:	08/21/08	
Parameter	Value of sensor	Lab value	Status	
am4	2.2 mg/l (133 mV)	---	---	
NO3-N	8.5 mg/l (1201 mV)	---	---	
K	23.9 mg/l (217 mV)	---	---	
Job status: In process				
Please select the parameter and start measurement process by pressing <[TAB]/ENTER>				
				Select Job

IQ LabLink creates an automatic connection between the WTW IQ SENSOR NET process monitoring system and photometric laboratory measurement.

As all wastewater has a specific material composition (matrix), from time to time a fine adjustment of the online measurement is carried out via a matrix adjustment. The values for the matrix adjustment are determined with a photometer and transferred back to the correct sensor – without any cable clutter!

- Simple selection of the measurement settings
- Clearly listed multiple measurements
- Data output with commentary function



- Comfortable and menu-prompted reconciliation procedure
- Secure and fast data transfer via USB
- Automatic allocation when several sensors are used

## photoLab® color - color measurement instead of color perception

The photometric color measurement stands out in comparison to the visual procedure due to its objective and precise measurement: photoLab® color enables PC-controlled color measurement with the spectrophotometers of the photoLab® 6000 and 7000 Series for the quality control of substances from water to wine or from resin to sugar.

photoLab® color shines with its easy method selection and clearly listed multiple measurements with data output and commentary options. Supported measurements include CIE 15:2004, ADMI, Hazen, Yellowness, Gardner, etc.



-  **PC-controlled**
-  **Conforming to standards**
-  **CSV and PDF export**



### photoLab® Data spectral - data management made simple

The PC software module photoLab® Data spectral is for the photometers of the photoLab® 6000/7000 Series photometers. It offers a clear interface for easy data exchange between PCs and photometers as well as the GLP compliant further processing of datasets with LIMS or spreadsheet programs.

## Brewery application package for the photoLab® 6000/7000 Series

The package contains MEBAK standard methods for the measurement of the typical parameters in the brewing industry (EBC)

α-acids	Standard methods
Anthocyanins (Harris - Rickett method)	EBC
Bear measurement in beer*	EBC
Beer coloring	EBC
Beer measurement in wort*	EBC
Copper	EBC, cuprethol method
Flavonoids	EBC
Free amino nitrogen (FAN) in darker beers	EBC (with notification)
Free amino nitrogen (FAN) in darker worts	EBC (with notification)
Free amino nitrogen (FAN) in light beer	EBC (with notification)
Free amino nitrogen (FAN) in light worts	EBC (with notification)
Iron	EBC methods with calibration line
Iso-α-acids (only with photoLab® 7600 UV-VIS!)	Multiple wavelength method
Nickel	EBC
Photometric iodine test	Method with adjustment factor
Reduction capacity	
Steam-volatile phenols	Methods with calibration line
Thiobarbituric acid count TBA in beer and wort	
Thiobarbituric acid count TBA in congress wort	
Total carbohydrate	EBC
Total phenols	EBC
Vicinal diketones (diacetyl, 2,3-pentanedione)	EBC

НеваРеактив

## photoLab® 7100 VIS Spectrophotometer - Simplifying the routine



photoLab® 7100 VIS

- 320 - 1100 nm
- More than 250 standard methods
- Special methods
- Color measurement

### From aquaculture to environmental monitoring

Fast and cost-effective routine analysis with AQA for wastewater, drinking water, environmental monitoring, and monitoring authorities as well as special procedures for environmental parameters such as chlorophyll or industrial fish farming.

### From wine to science

Menu based guidance makes complex application procedures in the food and beverage industry, production operations, or service laboratories fast, simple, and clear.

- Preprogrammed multi-step or multiple wavelength methods
- Comprehensive programming options for user applications
- Absorption spectra and kinetics measurements
- Instruction in essentials and modern photometrics in teaching and training.
- Complex color measurement with the PC-based software photoLab® color (see page143).

НеваРеактив

## photoLab® 7600 UV-VIS Spectrophotometer - with OptRF



photoLab® 7600 UV-VIS

The photoLab® 7600 UV-VIS spectrophotometers combines tried and tested routine functions with pathbreaking spectral analytical functions and OptRF for reagent-free measurement. It is the one system for reference measurements for process systems to special applications in laboratory analysis.

- **190 - 1100 nm**
- **OptRF reagent free methods for COD, NO<sub>3</sub>, NO<sub>2</sub>**
- **Comprehensive programming options**

### OptRF - optical reagent-free measurement of COD, nitrate and nitrite

OptRF has brought online measurement into the laboratory: COD, nitrate and nitrite can be recorded, calculated, and immediately displayed as a measurement value using a spectral scan in a quartz cuvette. The range of application for OptRF include:

- Communal wastewater treatment plants and, partially, septic tanks
- Many surface waters (COD, NO<sub>3</sub>; after pre-tests)
- Cost-free measurement range check for routine analysis
- Quick reference measurement for the matrix adjustment of online sensors

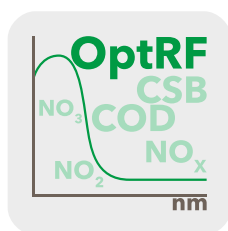

- **Faster than the fastest digestion**
- **Free of cost due to no reagents or chemicals**
- **Environmentally-friendly and harmless to health**



### UVT and SAC

These parameters are increasingly important for checking UV disinfection as well as monitoring of the organic load: There are a total of five methods with and without turbidity adjustment available.

### From training to the sugar industry

There are special methods and comprehensive programming for user-defined applications available for varied and mixed tasks in the range of 190-1100 nm. This supports universities in research and training, mixed applications in the food and beverage production industries, or service laboratories with specialist tasks.

## On the go with the photoLab® 7000 Series – mobile applications



photoLab® in the field case

The light and handy photoLab® 7000 series spectrophotometers can be used on-site with a car battery to, for example, monitor and take reference measurements of water operations and for official monitoring.

Alongside a transport case, a 12 V adapter cable for operation with standard trade car batteries is available as an accessory.

## photoLab® Technical Data Spectrophotometer

Model	photoLab 7100 VIS	photoLab 7600 UV-VIS
Wavelength range (nm)	320-1100 nm	190-1100 nm
Optical system	Grating monochromator	
Light source	Wolfram halogen	Xenon flashbulb
Spectral bandwidth [nm]	4 nm	
Display	Backlit color 7-inch graphic display	
Wavelength precision (nm)	± 1 nm	
Wavelength reproducibility (nm)	< 0.5nm	
Photometric precision	- 0.003 E for E < 0.600; - 0.5 % of the display for 0.600 < E < 2.000	
Photometric reproducibility	- 0.003 E for E < 0.600; - 0.5 % of the display for 0.600 < E < 2.000	
Photometric dissolution	0.5% of the measurement value or 0.005 E in absorbance 2	
Photometric linearity	< 1% for E ≤ 2.000 in the range from 340 to 900 nm	
Scan speed [nm/s]	approx. 13 nm/s	approx. 16 nm/s
Scattered light	< 0.1% T at 340 and 408 nm	< 0.05% T at 340 and 408 nm
Interfaces	Ethernet, USB B, USB A	
Dimensions (L x W x H in cm)	404 x 197 x 314 mm (width x height x depth)	
Weight [kg]	approx. 4.5 kg	

## Order information

Model		Order no.
photoLab® 7100 VIS	Spectrophotometer for spectral and systematic analytics of 320 - 1100 nm	250 203
photoLab® 7600 UV-VIS	Spectrophotometer for spectral and systematic analytics of 190 - 1100 nm	250 204
photoLab® color + Data spectral	PC software for color measurement and for simple data management	902 763
PL6-BREW	Application package for the brewing industry as per MEBAK/EBC	250 214
spectral 6/7	Transport case for the photoLab® 6000 and 7000 Series	250 212
Adapter	Adapter for 12V (auto-) operation for the photoLab® 6000 and 7000 Series	902 760
Accessories	cables see price list or <a href="http://www.WTW.com">www.WTW.com</a>	

# photoLab® S6 and S12 – measure instantly and precisely!

The photoLab® Filter Photometers S6/S12 offer laboratory precision in combination with the greatest speed. This is particularly advantageous in routine operations for water analysis:

- **Multilevel AQA/IQC**
- **Automatic cuvette recognition**
- **Barcode recognition for all cuvette types**



photoLab® S12 and S6

## Open cover, insert cuvette, read measurement immediately!

Speed and precision come from the filter technology used with reference beam technology. In connection with coded round and rectangular cuvette tests, a highly efficient and cost-effective measurement is possible for all requirements. The set wavelengths via highly precise filters provides a mechanical and therefore practically maintenance-free measurement instrument:

- AutoCheck for greater stability and precision
- Automatic cuvette recognition for *all* cuvette sizes used
- Automatic test recognition via barcodes for round *and* rectangular cuvette tests
- Automatic measurement activation
- **Analytic Quality Assurance AQA/IQC:**
- Large selection of programmed test kits: from easy round cuvette tests to cost-effective reagent tests



## photoLab® S6

Filter photometers with 6 wavelengths for all current routine determinations with round cuvettes in wastewater and drinking water analytics, but also in training.

The instrument is therefore uncomplicated and easy to operate during:

- Occasional measurements
- The use of round cuvette tests for quick measurement results
- Standard measurements with simpler safeguarding

## photoLab® S12

Filter photometers with 12 wavelengths for comprehensive routine measurements in service laboratories. Alongside coded quick test kits (round cuvettes), there are a large number of cost-effective reagent test kits for rectangular cuvettes available. The barcode support is also unique for these test kits in 10 mm, 20 mm and 50 mm rectangular cuvettes. As a result, the lowest concentration ranges can be determined even in drinking water analysis. In addition, 50 custom methods are programmable and kinetic measurements are possible:

The instrument is therefore highly efficient and cost-effective for:

- Routine determinations with a large number of samples
- Measurement of the lowest concentrations
- Custom applications with custom methods

## Technical specifications: Filter photometer photoLab® S6/S12

	photoLab® S6 and S6-A	photoLab® S12 and S12-A
<b>Type</b>	Filter photometer	Filter photometer
<b>Photodiode array for</b>	6 wavelengths	12 wavelengths
<b>Wavelengths nm</b>	340, 445, 525, 550, 605, 690	340, 410, 445, 500, 525, 550, 565, 605, 620, 665, 690, 820
<b>Custom methods</b>	-	50
<b>Auto zero adjustment</b>	Yes	Yes
<b>AutoSelect function</b>	Yes	Yes
<b>Cuvette recognition</b>	Yes	Yes
<b>Cuvette type</b>	Round	Round, 10 mm, 20 mm and 50 mm
<b>Data storage and time</b>	500 data sets; with date and time	1000 data sets; with date and time
<b>Essential functions</b>	Concentration, absorption and transmission measurement, AQA/IQC, RS 232 interface	Concentration, absorption and transmission measurement, AQA/IQC, kinetics, RS 232 interface
<b>Battery operation (optional)</b>	1 work day, deep discharge protection, trickle charging with mains operation	1 work day, deep discharge protection, trickle charging with mains operation
<b>Test mark</b>	CE	CE
<b>Guarantee period</b>	2 years	2 years

## Order information: Filter photometer photoLab® S6/S12

Model	Description	Order No.
photoLab® S6	Mains version, universal plug (other mains supplies/country variants on request)	250013
photoLab® S6-A	Battery version	250022
photoLab® S12	Mains version, universal plug (other mains supplies/country variants on request)	250024
photoLab® S12-A	Battery version	250026

For additional accessories and cables, see price list or [www.WTW.com](http://www.WTW.com)

# pHotoFlex®: The “real” multi-parameter photometer for mobile applications

The pHotoFlex® Series offers the unique combination of photometrics, pH, ORP and turbidity measurements. It combines precision with low energy needs due to the use of optical filters in combination with LEDs for six wavelengths.

The electrochemical pH/ORP measurement and the turbidity measurement are integrated in the pHotoFlex® pH and pHotoFlex® Turb. This makes them the perfect companion for all on-site measurements: in treatment plants for wastewater and reference measurements, in drinking water analysis at wellheads or in cisterns, and last but not least for general water monitoring.

- **Precise and robust**
- **Different cuvettes usable**
- **AQA and GLP support**



pHotoFlex® field case set - the outdoor lab

pHotoFlex® instruments are handy, energy-efficient, and also offer many extras:

- Clever adapter solution for different cuvette types: ø 28 mm and 16 mm, lengths from 92 to 104 mm
- User guidance for simple operation, even without the manual
- Large test selection and large measurement ranges
- Storage with sample identification

- Integrated pH function with pHotoFlex® pH
- Turbidity measurement as per DIN 27027 / ISO 7027 and pH measurement with pHotoFlex® Turb
- Custom methods via the LSdata PC software
- Quick selection of the ten most common test kits from a favorites list
- Case sets with integrated “laboratory table” for comfortable on-site work (see page146)
- Easy work via barcode: Barcodes are contained in the analysis requirements. Simply hang barcode lists up in the workplace and select them via LabStation test with the barcode scanner





## pHotoFlex® STD - portable photometer for on-site water analysis and routine measurement

The portable pHotoFlex® STD makes taking on-site photometric measurements for water analysis and other routine measurements simple, comfortable and energy-efficient. The basic model from the pHotoFlex® Series offers six wavelengths using LEDs, with approx. 3000 measurements possible per battery set.

100 pieces of measurement data can be stored, filtered and transferred to the PC or easily managed and processed using the optional LSdata PC software in a GLP-compliant way.

The pHotoFlex® STD is even easier to use in the laboratory in connection with a LabStation: mains operation and the use of a barcode reader is then possible. The LabStation also serves as a charging station for the rechargeable battery delivered along with it.

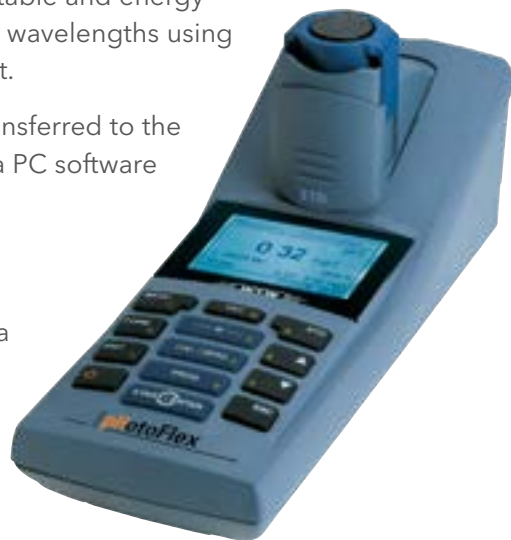

pHotoFlex® STD

- **Pure photometry**
- **Intuitive and easy to operate**
- **More than 180 methods**



## pHotoFlex® pH – Portable photometer with pH measurement function



with pH measurement chain SenTix® 41

The pHotoFlex® pH portable photometer shows its strength in more complex tasks in multi-site environmental and process applications.

### Integrated pH function

The integrated pH function facilitates measurements from pH 0-16 with automatic buffer recognition (TEC/NIST). The temperature compensation takes place automatically in the reliable measurement range of -5 ... 100 °C. The MultiCal® Routine facilitates automatic calibration with up to three calibration points.

- **Integrated pH and ORP measurement**
- **Automatic temperature compensation**
- **CO<sub>2</sub> and NH<sub>3</sub> determination**

## pHotoFlex® Turb – the real multi-parameter photometer

pHotoFlex® Turb is the real multi-parameter photometer with pH, ORP, and turbidity measurement all-in-one instrument. It corresponds to the pHotoFlex® pH and also has an infrared light source (IR) for nephelometric turbidity measurement (90°) per DIN 27027/ISO 7027. The precision is equivalent to a laboratory turbidity meter. In combination with the AMCO Clear® Standards, the highest possible precision is also provided for the sensitive drinking water sector. As a result users with high AQA requirements can also carry out in-the-field water analysis at on-site cisterns or wells.

The calibration of the AMCO Clear® Standards delivered can be documented and - in addition to the measurement values - displayed via a RS 232 interface.



pHotoFlex® Turb

- **Turbidity measurement as per DIN 27027 / ISO 7027**
- **Measurement range 0-1100 NTU/FNU**
- **On-site quality control (QC)**

## Sets in a portable case – secure on-site work!

The mini-laboratory with integrated "laboratory table" has compartments for the measurement instrument, cuvettes, measuring beakers, and a stand for the pH electrode.

Complete sets with:

- pH electrode SenTix® 41
- Calibration standard (pHotoFlex® Turb)
- LSdata for easy data management and method establishment
- Lots of useful accessories: Empty cuvettes, buffer solutions with pH 4.01 and 7.00, AK Laboratory 540 PC cable, stand for the pH electrode, cleaning cloths, screwdriver
- Optionally available with variably adjustable 5 ml pipette no. 250 546 (pHotoFlex® pH/Turb) or segmented syringes (pHotoFlex® STD)

- **The laboratory for enroute**
- **Integrated "laboratory table"**
- **Data management**



Mobile laboratory

## LabStation and LSdata – The smart way to manage your measurement data!

With the portable pHotoFlex® pH photometers and the Turb® 430 turbidity meters, the LabStation provides the ideal laboratory solution. With the LSdata PC software the measurement data recorded can be easily processed on the PC. It is included in the LabStation and case set delivery package. LSdata is also available as an individual package. The LabStation also serves as a charging station for the included rechargeable battery set.

- GLP-compliant data export from the measurement instrument to the PC with user recognition
- Processing in \*.XLS format, for, for example, the clear documentation of the respective individual sampling locations
- Custom methods can be created, managed and synchronized between PC and measurement instrument via a user-friendly dialog window.
- The calculation of the calibration curve for custom methods



## Even more tests:

For field use, alongside lot-certified reagents, there are also simple powder tests for when you're on the go. pHotoFlex® offers the option to adjust the incline of calibration curves.

*You can find the complete reagent program from page 150.*



## Technical data: pHotoFlex® portable photometers

Model	pHotoFlex® STD	pHotoFlex® pH	pHotoFlex® Turb
<b>Light source</b>	LED	LED	LED
<b>Wavelengths nm</b>	436, 517, 557, 594, 610, 690	436, 517, 557, 594, 610, 690	436, 517, 557, 594, 610, 690 + 860
<b>Custom methods</b>	50	100	100
<b>Methods/software update</b>	Via the Internet	Via the Internet	Via the Internet
<b>Data memory</b>	100 measurements	1000 measurements	1000 measurements
<b>pH</b>	–	0-16	0-16
<b>Turbidity</b>	–	–	0-1100 NTU/FNU
<b>Precision</b>	<b>Photometry</b> <2 nm wavelength precision, 0.005 abs. reproducibility	<2 nm wavelength precision, 0.005 abs. reproducibility	< 2 nm wavelength precision, 0.005 abs. reproducibility
	<b>pH</b> –	±0.01 pH	±0.01 pH
	<b>Turbidity (NTU/FNU)</b> –	–	0.01 NTU/FNU or ±2% of the measurement value
<b>Calibration:</b>	<b>pH/turbidity</b> –	3-point	3-point
<b>Interface</b>	RS 232, USB via adapter (optional)	RS 232, USB via adapter (optional)	RS 232, USB via adapter (optional)
<b>Measurement type</b>	Photometry	Photometry, pH, ORP	Photometry, pH, ORP, turbidity
<b>Battery</b>	4 Mignon (AA), over 3000 measurements	4 Mignon (AA), over 3000 measurements	4 Mignon (AA), over 3000 measurements
<b>Rechargeable battery</b>	Optional: LabStation	Optional: battery or Lab station	Optional: battery or Lab station
<b>Test mark</b>	cETLus	cETLus	cETLus
<b>Guarantee</b>	2 years	2 years	2 years

## Order info: pHotoFlex® portable photometers and accessories

Model	Description	Order No.
<b>pHotoFlex® STD</b>	Portable photometer	251105
<b>pHotoFlex® pH</b>	Portable photometer with pH measurement	251100
<b>pHotoFlex® Turb</b>	Portable photometer with pH and turbidity measurement as per DIN 27027/ISO 7027	251110
<b>pHotoFlex® pH/SET</b>	Portable, universal LED filter photometer in field case with table insert, LSdata and accessories	251200
<b>pHotoFlex® Turb/SET</b>	Portable, universal LED filter photometer with pH and turbidity measurement in field case with table insert, calibration kit, LSdata and accessories	251210
<b>LSdata</b>	PC software for pHotoFlex®/Turb® 430 Series	902762
<b>FC pHotoFlex®/Turb® 430</b>	Field case and table insert for all pHotoFlex® and Turb® 430 models	251304
<b>LS Flex/430</b>	LabStation for all pHotoFlex® and Turb® 430 models with LSdata software, rechargeable battery and universal power supply	251301
<b>Rechargeable battery</b>	Rechargeable battery for pHotoFlex® pH/Turb and Turb® 430 IR/T with universal power plug	251300

For further accessories & cables see price list or [www.WTW.com](http://www.WTW.com)

# Thermoreactors for COD and all other thermal digestions

Thermoreactors are required for the determination of COD, total nitrogen or total phosphorous as well as electroplating. Due to the high reaction temperature over a defined time, the complete digestion of the sample is guaranteed. There are also three crack sets available for the sample digestion: Crack Set 10 (Model 14687, 100 digestions) and Crack Set 10-C (Model 14688, 25 cuvettes) for heavy metals, as well as Crack Set 20 for total nitrogen (Model 14963, 90 determinations).

The most important temperatures and digestion times are stored in the programs in each of the WTW Thermoreactors: there are eight easily selectable programs available. In addition, thermoreactors CR 3200 and CR 4200 also offer, alongside the eight set programs, the option of storing a further eight custom programs. The bores are suitable for cuvettes with an outer diameter of 16 mm.

## CR 2200

If you have to carry out routine tasks in water analysis with smaller sample amounts, the CR 2200 is perfect for you: 12 sample cuvettes can be unlocked here with 8 programs at 100, 120, 148 and 150°C.



## CR 3200

The CR 3200 has 2x12 cuvette slots, all of which can be opened with the same program. The CR 3200 also allows for eight custom programs with free selection of temperature up to 170 °C.



## CR 4200

If you need to carry out several measurements at the same time, the CR 4200 is the right choice: using the two separately controlled thermo blocks for each 12 cuvettes, here, for example, you can carry out measurements for COD (148 °C) and total-N (120 °C) at the same time. 8 user-defined programs up to 170 °C are also possible



## TFK CR Temperature Probe for quality assurance

The external TFK CR Temperature Probe (order no. 250100) is available as test equipment for the CR 3200 and CR 4200 models. The temperature probe can be inserted into the thermo reactor instead of a sample and provides the target and actual values determined either via a printer or via the PC.

It is therefore possible to monitor the digestion temperature and document it.



## Quick digestion for COD

There are various programs in accordance with international standards for the COD digestion. Due to many user requests, a quick digestion is also available for 20 minutes at 148 °C, as this time period has been proven to be sufficient in practice in communal wastewater operations.

All devices have relevant timer functions. There will be a display on all thermoreactors when the reaction temperature is reached.

### Safety measures

All thermoreactors have optimal heat transfer between the heat block and cuvette, and have a high level of safety. An integrated safety cover provides protection in the case of a potential cuvette break. On the heat block surface, a cover prevents the heat block being touched.

## Application scopes and technical data: Thermoreactors

Application scope	CR 2200	CR 3200	CR 4200
<b>Routine measurements</b>	●	●	●
<b>Wastewater</b>	●	●	●
<b>Specialist tasks in wastewater</b>	-	●	●
<b>Different programs in parallel</b>	-	-	●
<b>Number of samples, max.</b>	1 x 12	2 x 12, same program	2 x 12, different programs
<b>8 saved programs incl. COD quick digestion</b>	100 °C 30 min, 60 min 120 °C with 30 min, 60 min, 120 min, 148 °C 120 min, 20 min, 150 °C 120 min	100 °C 30 min, 60 min 120 °C with 30 min, 60 min, 120 min, 148 °C 120 min, 20 min, 150 °C 120 min	100 °C 30 min, 60 min 120 °C with 30 min, 60 min, 120 min, 148 °C 120 min, 20 min, 150 °C 120 min
<b>Custom programs</b>	-	8 freely selectable 25-170 °C	8 freely selectable 25-170 °C
<b>Control accuracy</b>	±1 °C ±1 digit		
<b>Protection class</b>	I (as per DIN VDE 0700 Part 1/11.90)		
<b>Device safety</b>	EN 61010, UL 3101, CAN/CSA C22.2-1010; EN 61010-2-010, IEC-CAN/CSA C22.2-1010.2.010		
<b>Dimensions</b>	B: 256 mm H: 185 mm (closed) 290 mm (open) D: 315 mm		

## Order information: Thermoreactors

Model	Description	Order No.
<b>CR 2200</b>	Reactor (230 VAC with Euro plug*) for COD and other chemical developments Suitable for the reception of 2x12 reaction cuvettes	1P21-1
<b>CR 3200</b>	Universal reactor (230 VAC with Euro plug*) for COD and other chemical developments Suitable for the reception of 2x12 reaction cuvettes	1P22-1
<b>CR 4200</b>	Universal reactor (230 VAC with Euro plug*) for COD and other chemical developments Suitable for the reception of 2x12 reaction cuvettes Two separately controllable heat zones.	1P23-1

\* Accessories & cables, see price list or www.WTW.com

\*) other power plugs available

# Reagents from A to Z - for every application the right test kit

Depending on the application, there are a variety of test kits available for routine investigations. Photometers and test kits together form a system in which each is coordinated with the other depending on optics and the wavelength used, and which offers various advantages:

For use with in-the-field photometers, test kits must be simple: The energy-efficient LED optics facilitate the monitoring process via the use of often simpler and more cost-effective test kits, for example, for a powder test. In the laboratory, on the other hand, the elaborate instrument technology with barcodes and the highest level of optical sensitivity is also mirrored in the highly-precise test kits available: through the use of barcodes, lot certificates and quality assurance support.

The reagent offering is continuously expanding with the development of new tests and inclusion of existing tests in the photometer offering. Just as important as selecting the right reagent is understanding that the instrument technology may impact the test range, depending on light source and optics. For example, LED photometers typically have a smaller measurement range vs. other light sources for the same test.

## Reagents for routine tests

- Quick, reliable, cost-effective
- The right test for every application
- Guaranteed results through AQA/IQC



## Measure correctly

Most errors result from the selection of the incorrect measurement range: Measurement tolerance increases closer to the upper and lower ends of the

measurement range. This is particularly significant in the lower range. Lot certificates show borders and key procedural data. So, once again, please measure with the right test kit!

## Test type overview

Labeling: ● = round cuvette test   TC = cuvette test   TP = powder test   ■ = reagent tests

Type	Cuvette test	Reagent test	Powder test
<b>Lot certificate</b>	With certificate (●) for the highest precision Without certificate (TC) for very good precision	With certificate (■) for the highest precision	Without certificate (TP), precise
<b>Test recognition</b>	Barcode (●) and/or method selection	Barcode and/or method selection	Method selection, barcode optional (external)
<b>Advantages:</b>	Reaction cuvette with barcode or method selection, 16 mm: Sample addition, insertion, measurement and reading with minimum work effort AQA support for stored results	Large measurement range for 10, 20 and 50 mm rectangular cuvettes, recording of the smallest concentrations in rectangular cuvettes up to 50 mm AQA support for stored results	Lowest pack size, simple test procedure, few utensils, for cuvettes in Ø 16 and 28 mm
<b>Area of application:</b>	Laboratory, infrequent work, or ease with very large sample sizes	Laboratory, low concentrations, routine, cost-effective work with very large sample sizes	Portable field measurements, screening and monitoring tasks

# Reagents

Model	Measurement range (max. specification)	Cuvette (mm) <sup>1)</sup> depending on photometer	ml	Order No.	Total	CC	SW	photoLab®			pHotoFlex®
								S6	S12	6000/7000	
<b>Aluminum Al</b>											
● 00594	0.02 - 0.50 mg/l Al	16	6	252068	25	-	✓	-	●	●	-
■ 14825	0.020 - 1.20 mg/l Al	10, 20, 50, 28	5	250425	300	✓	✓	-	●	●	●
TP AI-1 TP	0.002 - 0.250 mg/l Al	28	20	251400	100	-	-	-	-	-	●
<b>Ammonia NH<sub>3</sub> (dependent on pH value and temperature)</b>											
● 14544	0.09 - 3.00 mg/l NH <sub>3</sub> (pH 8.5/25 °C) 0.5 - 16.0 mg/l NH <sub>4</sub> -N	16	0.5	250329	25	✓	✓	-	-	●	●
■ 14752/1	0.002 - 0.730 mg/l NH <sub>3</sub> (pH 8.5/25 °C) 0.010 - 3.00 mg/l NH <sub>4</sub> -N	10, 20, 50, 16, 28	5	250426	500	✓	✓	-	-	●	●
■ 14752/2	0.002 - 0.730 mg/l NH <sub>3</sub> (pH 8.5/25 °C) 0.010 - 3.00 mg/l NH <sub>4</sub> -N	10, 20, 50, 16, 28	5	252081	250	✓	✓	-	-	●	●
TP NH <sub>4</sub> -1 TP	0.01 - 0.50 mg/l NH <sub>4</sub> -N 0.013 - 0.64 mg/l NH <sub>4</sub> <sup>+</sup>	28	10	251408	200	-	-	-	-	-	●
TC NH <sub>4</sub> -2 TC (LR)	0.02 - 2.50 mg/l NH <sub>4</sub> -N 0.03 - 3.20 mg/l NH <sub>4</sub> <sup>+</sup>	16	2	251997	50	-	-	-	-	-	●
TC NH <sub>4</sub> -3 TC (HR)	0.4 - 50.0 mg/l NH <sub>4</sub> -N 0.5 - 64.4 mg/l NH <sub>4</sub> <sup>+</sup>	16	0.1	251998	50	-	-	-	-	-	●
<b>Ammonium NH<sub>4</sub></b>											
● 14739	0.010 - 2,000 mg/l NH <sub>4</sub> -N 0.01 - 2.58 mg/l NH <sub>4</sub> <sup>+</sup>	16	5	250495	25	✓	-	●	●	●	-
● A6/25	0.20 - 8.00 mg/l NH <sub>4</sub> -N 0.26 - 10.3 mg/l NH <sub>4</sub> <sup>+</sup>	16	1	252072	25	✓	✓	●	●	●	●
● 14544	0.5 - 16.0 mg/l NH <sub>4</sub> -N 0.6 - 20.6 mg/l NH <sub>4</sub> <sup>+</sup>	16	0.5	250329	25	✓	✓	●	●	●	●
● 14559	4.0 - 80.0 mg/l NH <sub>4</sub> -N 5.2 - 103.0 mg/l NH <sub>4</sub> <sup>+</sup>	16	0.1	250424	25	✓	✓	●	●	●	-
■ 14752/1	0.010 - 3.00 mg/l NH <sub>4</sub> -N 0.013 - 3.86 mg/l NH <sub>4</sub> <sup>+</sup>	10, 20, 50, 16, 28	5	250426	500	✓	✓	-	●	●	●
■ 14752/2	0.010 - 3.00 mg/l NH <sub>4</sub> -N 0.013 - 3.86 mg/l NH <sub>4</sub> <sup>+</sup>	10, 20, 50, 16, 28	5	252081	250	✓	✓	-	●	●	●
■ 00683	2.0 - 150 mg/l NH <sub>4</sub> -N 2.6 - 193 mg/l NH <sub>4</sub> <sup>+</sup>	10	0.1, 0.2	252027	100	✓	✓	-	●	●	-
TP NH <sub>4</sub> -1 TP	0.01 - 0.50 mg/l NH <sub>4</sub> -N 0.013 - 0.64 mg/l NH <sub>4</sub> <sup>+</sup>	20, 28	10	251408	200	-	-	-	-	●	●
TC NH <sub>4</sub> -2 TC (LR)	0.02 - 2.50 mg/l NH <sub>4</sub> -N 0.03 - 3.20 mg/l NH <sub>4</sub> <sup>+</sup>	16	2	251997	50	-	-	-	-	●	●
TC NH <sub>4</sub> -3 TC (HR)	0.4 - 50.0 mg/l NH <sub>4</sub> -N 0.5 - 64.4 mg/l NH <sub>4</sub> <sup>+</sup>	16	0.1	251998	50	-	-	-	-	●	●

Water sampler

pH

ORP

ISE

Dissolved Oxygen

Conductivity

BOD/Respiration

Photometry

Turbidity

Software, Documentation

**Antimony:** request application documents

<b>AOX</b>											
● 00675	0.05-2,50 mg/l AOX	16		252023	25	-	-	●	●	●	-

<b>Arsenic</b>											
■ 01747	0.001 - 0.100 mg/l As	10, 20, 16	350	252063	30	-	-	-	●	●	●

in addition: AS absorption pipe required

				252066							
--	--	--	--	--------	--	--	--	--	--	--	--

**ascorbic acid:** request application documents

● = cuvette test; TC = cuvette test; CC = CombiCheck; ml = sample volume (photoLab®); 1) Ø 16, 28  
 ■ = point tests; TP = powder test; SW = sea water; □ 10, 20, 50





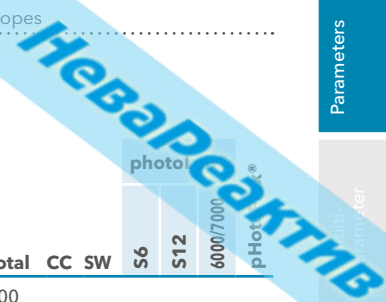

Model	Measurement range (max. specification)	Cuvette (mm) <sup>1)</sup> depending on photometer	ml	Order No.	Total	CC	SW	S6	S12	6000/7000	pHot <sup>®</sup>
00088 Reagent Cl <sub>2</sub> -3				252079	600						
00089 Accessories Cl <sub>2</sub> (empty cuvettes etc.)				252080	25						

**Chromate (chrome VI and total chrome) Cr**

● 14552	0.05 - 2.00 mg/l Cr	16	10	250341	25	-	✓	●	●	●	●
■ 14758	0.01 - 3.00 mg/l Cr	10, 20, 50	5	250433	250	-	✓	-	●	●	-

**Chrome bath CrO<sub>3</sub>:** see reagent-free tests

**COD Chemical Oxygen Demand**

● 14560	4.0 - 40.0 mg/l COD (148 °C, 2 h)	16	3	250303	25	✓	-	●	●	●	-
● 01796	5.0 - 80.0 mg/l COD (148 °C, 2 h)	16	2	252092	25	✓	-	●	●	●	-
● C3/25	10 - 150 mg/l COD (148 °C, 2 h)	16	3	252070	25	✓	-	●	●	●	●
● 14895	15 - 300 mg/l COD (148 °C, 2 h)	16	2	250359	25	✓	-	●	●	●	●
● 14690	50 - 500 mg/l COD (148 °C, 2 h)	16	2	250304	25	✓	-	●	●	●	●
● C4/25	25 - 1500 mg/l COD (148 °C, 2 h)	16	3	252071	25	✓	-	●	●	●	●
● 14691	300 - 3500 mg/l COD (148 °C, 2 h)	16	2	250351	25	✓	-	●	●	●	●
● 14555	500 - 10000 mg/l COD (148 °C, 2 h)	16	1	250309	25	✓	-	●	●	●	●
● 01797	5000 - 90000 mg/l COD (148 °C, 2 h)	16	0.1	252093	25	-	-	●	●	●	●
TC	COD1 TC (LR)	3 - 150 mg/l COD (148 °C, 2 h)	16	251990	25	-	-	-	-	●	●
TC	COD2 TC (MR)	20 - 1500 mg/l COD (148 °C, 2 h)	16	251991	25	-	-	-	-	●	●
TC	COD3 TC (HR)	200 - 15000 mg/l COD (148°C, 2h)	16	251992	25	-	-	-	-	●	●

**COD Chemical Oxygen Demand (quicksilver-free, chloride is also recorded and/or disrupts in higher concentrations)**

● 09772	10 - 150 mg/l COD (148 °C, 2h)	16	2	250301	25	✓	-	●	●	●	●
● 09773	100 - 1500 mg/l COD (148 °C, 2h)	16	2	250306	25	✓	-	●	●	●	●

**Copper bath Cu:** see reagent-free tests

**Copper Cu**

● 14553	0.05 - 8.00 mg/l Cu	16	5	250408	25	-	✓	●	●	●	●
■ 14767	0.02 - 6.00 mg/l Cu	10, 20, 50, 16, 28	10	250441	250	-	✓	-	●	●	●
TP	Cu-1 TP	0.04 - 5.00 mg/l Cu	20, 28	251403	100	-	✓	-	-	●	●

**Cyanide (free and easily released cyanide) CN**

● 14561	0.010 - 0.500 mg/l CN	16	5	250344	25	-	-	●	●	●	●
■ 09701	0.002 - 0.500 mg/l CN	10, 20, 50	5, 10	250492	100	-	-	-	●	●	-

● = reagent-free cuvette test; TC = cuvette test; CC = CombiCheck; ml = sample volume (photoLab\*); 1) Ø 16, 28  
 ■ = reagent test; TP = powder test; SW = sea water; □ 10, 20, 50



Model	Measurement range (max. specification)	Cuvette (mm) <sup>1)</sup> depending on photometer	ml	Order No.	Total	CC	SW	S6	S12	6000/7000	photoLab®
<b>Cyanuric acid</b>											
■ 19253	2 - 160 mg/l cyanuric acid	20	5	252091	100	-	-	-	●	●	-
<b>DEHA/oxygen binder</b>											
■ 19251	0.020 - 0.500 mg/l DEHA	20	10	252089	200	-	-	-	●	●	-
TP DEHA TP	0.004 - 0.450 mg/l DEHA	20, 28	25	251421	100	-	-	-	-	●	●
<b>Detergents:</b> see tensides: anionic, cationic, non-ionic											
<b>Flouride F</b>											
● 00809	0.10 - 1.80 mg/l F	16	50	252094	25	-	-	●	●	●	●
■ 14598/1	0.10 - 20.0 mg/l F	10	5/0.5	252048	100	-	-	-	●	●	-
■ 14598/2	0.10 - 20.0 mg/l F	10	5/0.5	252083	250	-	-	-	●	●	-
<b>Formaldehyde HCHO</b>											
● 14500	0.10 - 8.00 mg/l HCHO	16	2	250406	25	-	-	●	●	●	●
■ 14678	0.02 - 8.00 mg/l HCHO	10, 20, 50	3	250331	100	-	-	-	●	●	-
<b>Gold Au</b>											
■ 14821	0.5 - 12.0 mg/l Au	10, 16	2	250436	80	-	✓	-	●	●	●
<b>Halogens (total):</b> see chlorine Cl <sub>2</sub> , bromide Br <sub>2</sub> , Iodine I <sub>2</sub> , Chlorine dioxide ClO <sub>2</sub> , Ozone O <sub>3</sub>											
<b>Hazen:</b> see reagent-free tests: Coloring											
<b>Heavy metals:</b> see iron Pb, cadmium Cd, chrome Cr											
<b>Hydrazine N<sub>2</sub>H<sub>4</sub></b>											
■ 09711	0.005 - 2.00 mg/l N <sub>2</sub> H <sub>4</sub>	10, 20, 50	5	250493	100	-	-	-	●	●	-
TP N <sub>2</sub> H <sub>4</sub> -1 TP	0.004 - 0.600 mg/l N <sub>2</sub> H <sub>4</sub>	20, 28	10	251416	100	-	-	-	-	●	●
<b>Hydrogen peroxide H<sub>2</sub>O<sub>2</sub></b>											
● 14731	0.25 - 20.0 mg/l H <sub>2</sub> O <sub>2</sub>	16	10	250402	25	-	✓	-	●	●	-
■ 18789	0.015 - 6.00 mg/l H <sub>2</sub> O <sub>2</sub>	10, 20	8	252067	100	-	-	-	●	●	-
<b>Iod I<sub>2</sub></b>											
■ 0606	0.050 - 10.00 mg/l I <sub>2</sub>	10, 20, 50	010	252015	200	-	-	-	●	●	-
<b>Iodine color index:</b> see reagent-free tests: Coloring											
<b>Iron Fe</b>											
● 14549	0.05 - 4.00 mg/l Fe	16	5	250349	25	✓	✓	●	●	●	●
● 14896	1.0 - 50.0 mg/l Fe	16	1	250361	25	-	-	●	●	●	●
■ 14761/1	0.005 - 5.00 mg/l Fe	10, 20, 50, 16, 28	5	250435	1000	✓	✓	-	●	●	●
■ 14761/2	0.005 - 5.00 mg/l Fe	10, 20, 50, 16, 28	5	250439	250	✓	✓	-	●	●	●
■ 00796	0.010 - 5.00 mg/l Fe	10, 20, 50	8	252042	150	✓	✓	-	●	●	-
Fe-1 TP	0.012 - 1.800 mg/l Fe	16, 28	10	251404	100	-	-	-	-	●	●
TP Fe-2 TP	0.02 - 3.00 mg/l Fe	16, 28	10	251405	100	-	-	-	-	●	●
<b>Lead Pb</b>											
● 14833	0.10 - 5.00 mg/l Pb	16	5	250313	25	✓	-	●	●	●	-
■ 09717	0.010 - 5.00 mg/l Pb	10, 20, 50, 16, 28	8	252034	50	✓	-	-	●	●	●

● = 16 mm cuvette test; TC = cuvette test; CC = CombiCheck; ml = sample volume (photoLab®); 1) Ø 16, 28  
 ■ = reagent test; TP = powder test; SW = sea water; □ 10, 20, 50

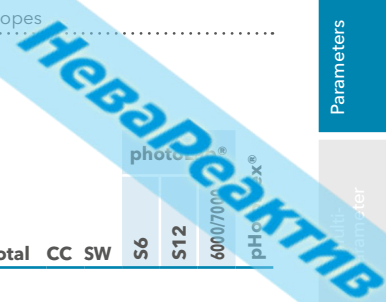

Model	Measurement range (max. specification)	Cuvette (mm) <sup>1)</sup> depending on photometer	ml	Order No.	Total	CC	SW	S6	S12	6000/7000 <sup>®</sup>	pHc <sup>®</sup>
<b>Magnesium Mg</b>											
● 00815	5.0 - 75.0 mg/l Mg	16	1	252043	25	-	✓	●	●	●	●
<b>Manganese Mn</b>											
■ 01739	0.005 - 2.00 mg/l Mn	10, 20, 50	8	252056	250	-	-	-	●	●	-
■ 14770/1	0.01 - 10.0 mg/l Mn	10, 20, 50, 16, 28	5	250442	500	✓	✓	-	●	●	●
■ 14770/2	0.01 - 10.0 mg/l Mn	10, 20, 50, 16, 28	5	252084	250	✓	✓	-	●	●	●
● 00816	0.10 - 5.00 mg/l Mn	16	7	252035	25	✓	-	●	●	●	●
TP Mn-1 TP	0.2 - 20.0 mg/l Mn	20, 28	10	251406	100	-	-	-	-	●	●
TP Mn-2 TP	0.007 - 0.700 mg/l Mn	20, 28	10	251417	100	-	-	-	-	●	●
<b>Molybdenum Mo</b>											
● 00860	0.02 - 1.00 mg/l Mo	16	10	252040	25	-	-	-	●	●	●
TP Mo-1 TP	0.3 - 35.0 mg/l Mo	20, 28	10	251407	100	-	-	-	-	●	●
TP Mo-2 TP	0.3 - 40.0 mg/l Mo	20, 28	25	251418	100	-	-	-	-	●	●
<b>Monochloramine</b>											
■ 01632	0.05 - 10.0 mg/l Cl <sub>2</sub> , t	10, 20, 50	10	252057	150	-	-	-	●	●	-
<b>Sodium Na</b>											
● 00885	10 - 300 mg/l Na	16	0.5	252044	25	-	-	●	●	●	●
<b>Nickel bath: see reagent-free tests</b>											
<b>Nickel Ni</b>											
● 14554	0.10 - 6.00 mg/l Ni	16	5	250409	25	✓	-	●	●	●	●
■ 14785	0.02 - 5.00 mg/l Ni	10, 20, 50, 28	5	250443	250	✓	-	-	●	●	●
<b>Nitrate NO<sub>3</sub></b>											
● 14556	0.10 - 3.00 mg/l NO <sub>3</sub> -N 0.4 - 13.3 mg/l NO <sub>3</sub>	16	2	250411	25	✓	✓	-	●	●	●
● N2/25	0.5 - 25.0 mg/l NO <sub>3</sub> -N 2.2 - 110.7 mg/l NO <sub>3</sub>	16	1	252073	25	✓	-	●	●	●	-
● 14542	0.5 - 18.0 mg/l NO <sub>3</sub> -N 2.2 - 79.7 mg/l NO <sub>3</sub>	16	1.5	250410	25	✓	-	●	●	●	●
● 14764	1.0 - 50.0 mg/l NO <sub>3</sub> -N 4 - 221 mg/l NO <sub>3</sub>	16	0.5	250347	25	✓	-	●	●	●	-
● 00614	23 - 225 mg/l NO <sub>3</sub> -N 102 - 996 mg/l NO <sub>3</sub>	16	0.1	252019	25	-	-	●	●	●	-
■ 14942	0.2 - 17.0 mg/l NO <sub>3</sub> -N 0.9 - 75.3 mg/l NO <sub>3</sub>	10, 16	1	250422	50	✓	✓	-	●	●	●
■ 14773	0.2 - 20.0 mg/l NO <sub>3</sub> -N 0.9 - 88.5 mg/l NO <sub>3</sub>	10, 20	1.5, 3	250444	100	✓	-	-	●	●	-
■ 09713/1	0.10 - 25.0 mg/l NO <sub>3</sub> -N 0.40 - 110.7 mg/l NO <sub>3</sub>	10, 20, 50	0.5	250421	90	✓	-	-	●	●	-

● = liquid and cuvette test; ■ = powder test; TC = cuvette test; TP = powder test; CC = CombiCheck; SW = sea water; ml = sample volume (photoLab<sup>®</sup>); 1) ∅ 16, 28; 10, 20, 50

Parameters

Water parameter

pH

ORP

ISE

Dissolved Oxygen

Conductivity

BOD/Respiration

Photometry

Turbidity

Software, Documentation

Model	Measurement range (max. specification)	Cuvette (mm) <sup>1)</sup> depending on photometer	ml	Order No.	Total	CC	SW	S6	S12	60007000	pHot®
■ 09713/2	0.10 - 25.0 mg/l NO <sub>3</sub> -N 0.40 - 110.7 mg/l NO <sub>3</sub>	10, 20, 50	0.5	252085	250	✓	-	-	●	●	-
TC NO <sub>3</sub> -1 TC	0.2 - 30.0 mg/l NO <sub>3</sub> -N 1 - 133.0 mg/l NO <sub>3</sub>	16	1	251993	50	-	-	-	-	●	●
<b>Nitrite NO<sub>2</sub></b>											
● N5/25	0.010 - 0.700 mg/l NO <sub>2</sub> -N 2.2 - 2.30 mg/l NO <sub>2</sub>	16	5	252074	25	-	✓	●	●	●	●
■ 14776/1	0.002 - 1.00 mg/l NO <sub>2</sub> -N 0.007 - 3.28 mg/l NO <sub>2</sub>	10, 20, 50, 16, 28	5	250445	1000	-	✓	-	●	●	●
■ 14776/2	0.002 - 1,000 mg/l NO <sub>2</sub> -N 0.007 - 3.28 mg/l NO <sub>2</sub>	10, 20, 50, 16, 28	5	250440	335	-	✓	-	●	●	●
● 00609	1.0 - 90.0 mg/l NO <sub>2</sub> -N 3.3 - 295.2 mg/l NO <sub>2</sub>	16	8	252069	25	-	-	●	●	●	-
TP NO <sub>2</sub> -1 TP	0.002 - 0.300 mg/l NO <sub>2</sub> -N 0.007 - 0.985 mg/l NO <sub>2</sub>	20, 28	10	251409	100	-	-	-	-	●	●
TC NO <sub>2</sub> -2 TC	0.03 - 0.60 mg/l NO <sub>2</sub> -N (LR) 0.10 - 1.97 mg/l NO <sub>2</sub> (LR) 0.30 - 3.00 mg/l NO <sub>2</sub> -N (HR) 0.99 - 9.85 mg/l NO <sub>2</sub> (HR)	16 16	2 0.5	251994	24	-	-	-	-	●	●
TP NO <sub>2</sub> -3 TP	0.002 - 0.300 mg/l NO <sub>2</sub> -N 0.007 - 0.985 mg/l NO <sub>2</sub>	20, 28	25	251419	100	-	-	-	-	●	●
<b>Nitrogen (total):</b> see total nitrogen N <sub>ges</sub>											
<b>Organic acids (volatile)</b>											
● 01749	50-3000 mg/l	round	0.5	252096	25	-	-	●	●	●	-
● / ■ 01809	50-3000 mg/l (100 °C, 15 min.)	16	0.5	252095	100	-	-	●	●	●	-
<b>Oxygen capacity up to pH 4.3</b>											
● / ■ 01758	KS <sub>4,3</sub> 0.40 - 8.00 mmol/l 20 - 400 mg/l CaCO <sub>3</sub>	16	1	252087	120	-	-	●	●	●	●
<b>Oxygen O<sub>2</sub></b>											
● 14694	0.5 - 12.0 mg/l O <sub>2</sub>	16	-	250403	25	-	-	●	●	●	-
<b>Ozone O<sub>3</sub></b>											
■ 00607/1	0.010 - 4.00 mg/l O <sub>3</sub>	10, 20, 50, 16, 28	10	252016	200	-	-	-	●	●	●
■ 00607/2	0.010 - 4.00 mg/l O <sub>3</sub>	10, 20, 50, 16, 28	10	252054	1200	-	-	-	●	●	●
<b>pH</b>											
● 01744	pH 6.4 - 8.8	16	10	252050	280	-	✓	●	●	●	-
<b>Phenol C<sub>6</sub>H<sub>5</sub>OH</b>											
■ 00856	0.002 - 0.100 mg/l C <sub>6</sub> H <sub>5</sub> OH 0.025 - 5.00 mg/l C <sub>6</sub> H <sub>5</sub> OH	20 10, 20, 50	200 10	252058	50 250	-	✓	-	●	●	-
● 14551	0.10 - 2.50 mg/l C <sub>6</sub> H <sub>5</sub> OH	16	10	250412	25	-	✓	-	●	●	●
<b>Phosphate PO<sub>4</sub></b>											
● P6/25	0.05 - 5.00 mg/l PO <sub>4</sub> -P 0.05 - 5.0 mg/l P <sub>ges</sub> 0.2 - 15.3 mg/l PO <sub>4</sub>	16	5	252075	25	✓	✓	●	●	●	●

● = cuvette test;  
■ = reagent tests;

TC = cuvette test;  
TP = powder test;

CC = CombiCheck;  
SW = sea water;

ml = sample volume (photoLab®);

1) Ø 16, 28  
□ 10, 20, 50

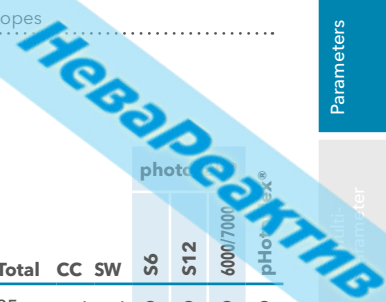

Model	Measurement range (max. specification)	Cuvette (mm)1) depending on photometer	ml	Order No.	Total	CC	SW	photoLab® photometer			
								S6	S12	6000/7000	pHotLab®
● P7/25	0.5 - 25.0 mg/l PO <sub>4</sub> -P 0.5 - 25.0 mg/l P <sub>ges</sub> 1.5 - 76.7 mg/l PO <sub>4</sub>	16	1	252076	25	✓	✓	●	●	●	●
● 14546	0.5 - 25.0 mg/l PO <sub>4</sub> -P 1.5 - 76.7 mg/l PO <sub>4</sub>	16	5	250413	25	✓	✓	●	●	●	●
● 00616	3.0 - 100.0 mg/l PO <sub>4</sub> -P 9.0 - 307.0 mg/l PO <sub>4</sub>	16	0.2	252021	25	-	✓	●	●	●	●
■ 14848/1	0.005 - 5.00 mg/l PO <sub>4</sub> -P 0.005 - 5.00 mg/l PO <sub>4</sub> -P <sub>ges</sub> 0.020 - 15.3 mg/l PO <sub>4</sub>	10, 20, 50, 16, 28	5	250446	420	✓	✓	-	●	●	●
■ 14848/2	0.005 - 5.00 mg/l PO <sub>4</sub> -P 0.005 - 5.00 mg/l PO <sub>4</sub> -P <sub>ges</sub> 0.020 - 15.3 mg/l PO <sub>4</sub>	10, 20, 50, 16, 28	5	252086	220	✓	✓	-	●	●	●
■ 14842	0.5 - 30.0 mg/l PO <sub>4</sub> -P 1.5 - 92.0 mg/l PO <sub>4</sub>	10, 20	5	250447	400	-	✓	-	●	●	-
■ 00798	1.0 - 100.0 mg/l PO <sub>4</sub> -P 3.0 - 307.0 mg/l PO <sub>4</sub>	10, 16	8	252045	100	-	✓	-	●	●	●
TP PO <sub>4</sub> -1 TP	0.007 - 0.800 mg/l PO <sub>4</sub> -P 0.02 - 2.50 mg/l PO <sub>4</sub>	20, 28	10	251410	100	-	-	-	-	●	●
TC PO <sub>4</sub> -2 TC	0.02 - 1.63 mg/l PO <sub>4</sub> -P 0.06 - 5.00 mg/l PO <sub>4</sub>	16	5	251989	50	-	-	-	-	●	●
TC PO <sub>4</sub> -3 TC	0.02 - 1.10 mg/l PO <sub>4</sub> -P 0.02 - 1.10 mg/l P <sub>ges</sub> (development, 100 °C) 0.06 - 3.37 mg/l PO <sub>4</sub>	16	5	251988	50	-	-	-	-	●	●
TC PO <sub>4</sub> -4 TC	0.02 - 1.10 mg/l PO <sub>4</sub> -P 0.02 - 1.10 mg/l P <sub>ges</sub> (development, 100 °C) 0.06 - 3.37 mg/l PO <sub>4</sub>	16	5	251987	50	-	-	-	-	●	●
<b>Potassium K</b>											
● 14562	5.0 - 50.0 mg/l K	16	2	250407	25	-	✓	●	●	●	●
● 00615	30 - 300 mg/l K	16	0.5	252020	25	-	✓	●	●	●	●
<b>Reagent-free COD Chemical Oxygen Demand with OptRF:</b> see page 159											
<b>SAC</b> see reagent-free tests											
<b>Silica:</b> see silicon Si											
<b>Silicon/silica Si</b>											
■ 14794	0.005 - 5.00 mg/l Si 0.01 - 10.70 mg/l SiO <sub>2</sub>	10, 20, 50, 16, 28	5	250438	300	-	✓	-	●	●	●
■ 00857	0.5 - 500 mg/l Si 1.1 - 1070 mg/l SiO <sub>2</sub>	10, 16	4/0.5	252046	100	-	-	-	●	●	●
TP Si-1 TP (LR)	0.005 - 0.748 mg/l Si 0.01 - 1.60 SiO <sub>2</sub>	20, 28	10	251411	100	-	✓	-	-	●	●
TP Si-2 TP (HR)	0.3 - 46.7 mg/l Si 0.7 - 100 mg/l SiO <sub>2</sub>	20, 16, 28	10	251412	100	-	✓	-	-	●	●
TP Si-3 TP (HR)	0.5 - 93 mg/l Si 1 - 200 mg/l SiO <sub>2</sub>	20, 28	25	251422	100	-	✓	-	-	●	●
<b>Silver Ag</b>											
■ 14831	0.25 - 3.00 mg/l Ag	10, 20, 16	10	250448	100	-	-	-	●	●	●

(Total Ag: 100 °C oder 120 °C, 1 h) digestion reagents contained in test kit

● = round cuvette test; reagent tests; TC = cuvette test; TP = powder test; CC = CombiCheck; SW = sea water; ml = sample volume (photoLab®); 1) Ø 16, 28 □ 10, 20, 50

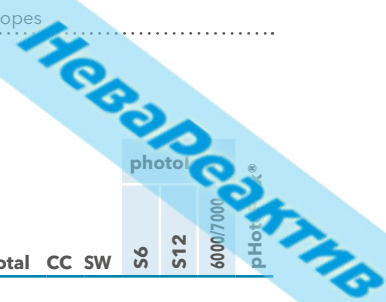

Model	Measurement range (max. specification)	Cuvette (mm) <sup>1)</sup> depending on photometer	ml	Order No.	Total	CC	SW	photoLab®			
								S6	S12	6000/7000	pHot®
<b>Sulfide/hydrogen sulfide S</b>											
● 14779	0.020 - 1.50 mg/l S	10, 20, 50	5	250450	220	-	-	-	●	●	-
<b>Sulfite SO<sub>3</sub></b>											
● 14394	1.0 - 20.0 mg/l SO <sub>3</sub>	16	3	250416	25	-	-	-	●	●	-
■ 01746	1.0 - 60.0 mg/l SO <sub>3</sub>	10	2	252053	150	-	-	-	●	●	-
<b>Sulphate SO<sub>4</sub></b>											
● 14548	5 - 250 mg/l SO <sub>4</sub>	16	5	250414	25	✓	✓	●	●	●	●
● 00617	50 - 500 mg/l SO <sub>4</sub>	16	2	252022	25	✓	✓	●	●	●	-
● 14564	100 - 1000 mg/l SO <sub>4</sub>	16	1	250415	25	✓	✓	●	●	●	-
■ 14791	25 - 300 mg/l SO <sub>4</sub>	10	2.5	250449	200	✓	-	●	●	●	-
TP	SO <sub>4</sub> -1 TP	2 - 70 mg/l SO <sub>4</sub>	20, 28	251413	100	-	✓	-	-	●	●
TP	SO <sub>4</sub> -2 TP	2 - 70 mg/l SO <sub>4</sub>	20, 28	251423	100	-	✓	-	-	●	●
<b>Tensides</b>											
a-Ten (anion.) ●	02552	0.05 - 2.00 mg/l SDSA	16	252102	25	-	-	-	-	●	-
c-Ten (cation.) ●	01764	0.05 - 1.50 mg/l k-ten	16	252062	25	-	-	-	●	●	-
n-Ten (non-ion.) ●	01787	0.10 - 7.50 mg/l n-ten	16	252061	25	-	-	-	●	●	●
<b>Tin Sn</b>											
● 14622	0.10 - 2.50 mg/l Sn	16	5	250401	25	-	✓	-	●	●	-
<b>TOC total organically-bound carbon</b>											
● 14878	5.0 - 80.0 mg/l TOC	16	3	252036	25	-	-	●	●	●	-
● 14879	50 - 800 mg/l TOC	16	3	252037	25	-	-	●	●	●	-
<b>Total nitrogen N<sub>ges</sub></b>											
● 14537	0.5 - 15.0 mg/l N <sub>ges</sub> (120 °C, 1 h)	16	10	250358	25	✓	-	●	●	●	●
● 14763	10 - 150 mg/l N <sub>ges</sub> (120 °C, 1 h)	16	1	250494	25	✓	-	●	●	●	-
● 00613	0.5 - 15.0 mg/l N <sub>ges</sub> (120 °C, 1 h)	16	10	252018	25	✓	-	●	●	●	-
TC	N <sub>tot</sub> 1 TC (LR)	0.5 - 25.0 mg/l N <sub>ges</sub> (120 °C, 30 min.)	16	2; 2	251995	50	-	-	-	●	●
TC	N <sub>tot</sub> 2 TC (HR)	10 - 150 mg/l N <sub>ges</sub> (120 °C, 30 min.)	16	0.5; 2	251996	50	-	-	-	●	●
<b>Total phosphate: see phosphate PO<sub>4</sub></b>											
<b>Water hardness, TH total hardness</b>											
● 00961	0.7 - 30.1 °d, 5 - 215 mg/l Ca	16	1	252039	25	-	-	●	●	●	●
<b>Water hardness, RH remaining hardness</b>											
● 14683	0.075 - 0.700 °d 0.50 - 5.00 mg/l Ca	16	4	250404	25	-	-	●	●	●	-

● = round cuvette test; TC = cuvette test; CC = CombiCheck; ml = sample volume (photoLab®); 1) Ø 16, 28  
 ■ = reagent tests; TP = powder test; SW = sea water; □ 10, 20, 50

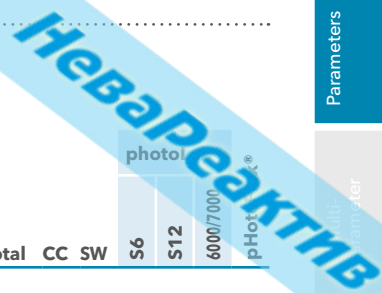

Model	Measurement range (max. specification)	Cuvette (mm) <sup>1</sup> depending on photometer	ml	Order No.	Total	CC	SW	photoLab®			
								S6	S12	6000/7000	pHot
<b>Zinc Zn</b>											
● 00861	0.025 - 1.000 mg/l Zn	16	2	252049	25	-	-	●	●	●	●
● 14566	0.20 - 5.00 mg/l Zn	16	0.5	250417	25	✓	-	●	●	●	●
■ 14832	0.05 - 2.50 mg/l Zn	10	5	250451	90	-	-	-	●	●	-
06146	Extraction agent, required (zinc reagent 6)			250452	180						

● = round cuvette test; TC = cuvette test; CC = CombiCheck; ml = sample volume (photoLab®); 1) Ø 16, 28  
 ■ = reagent tests; TP = powder test; SW = sea water; □ 10, 20, 50

## OptRF: optical reagent-free methods for COD, NO<sub>3</sub> and NO<sub>2</sub> measurements

The OptRF measurement of a liquid sample is based on a direct, spectral absorbance measurement in the UV range of 200 - 390 nm without the use of reagents. The measured spectrum is evaluated across the entire wavelength range. The concentration value calculation takes place automatically via complex algorithms and evaluation models saved as OptRF methods on the photometer. The OptRF methods available are specific for the respective measurement parameters and the application and/or measurement location.

The OptRF methods currently available have been developed and optimized for municipal wastewater treatment plant processes, and cover the following measurement parameters and measurement ranges in standard solutions:

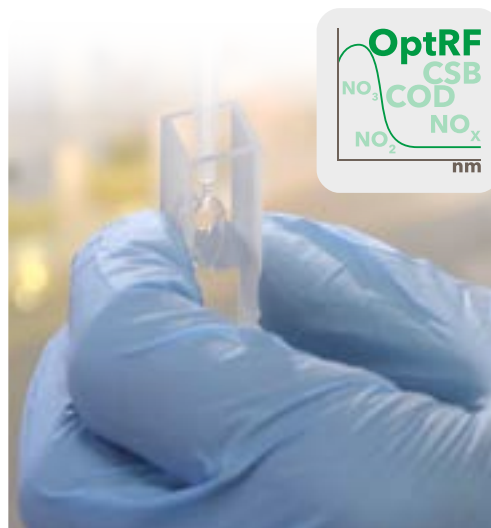

### Measurement parameters and areas of application

OptRF measurement methods	Parameter	Measurement range related to measurements in standards
3001 CODt_H_Outlet_10	COD <sub>total</sub> <sup>a</sup>	2 - 75 mg/L
3002 CODs_H_Outlet_10	COD <sub>dissolved</sub> <sup>b</sup>	2 - 75 mg/L
3003 NO3_H_Outlet_10	NO <sub>3</sub> -N	0.1 - 3.0 mg/L
3004 NO2_H_Outlet_10	NO <sub>2</sub> -N	0.1 - 4.0 mg/L

Water calibration can impact the borders of the measurement range for actual samples. OptRF methods can also be applied in samples with similar matrices, for example, certain surface waters. Other substances such as alcohols and sugar are not currently compatible with OptRF.



# Test equipment

## CombiCheck

CombiCheck solutions are ready-to-use multi-parameter standards. Every package contains a standard solution and an addition solution. Both solutions can be directly used, **without dilution**, for quality assurance.

- The standard solution ensures the accuracy of the results from the entire system: Work methods - analysis procedures - reagents - photometers.
- The addition solution allows you to check sample-dependent influences (MatrixCheck) through the measurement of the recovery rate and establishes the sample preparation necessary.

The maximum number of determinations with a CombiCheck standard solution depends on the test kit used. 280 determinations are always possible with the addition solution. Please take note of the instructions in the descriptions for the test kits!

Parameter	Concentration	Compatible test kit model	maximum number of determinations
<b>Model 14676 CombiCheck 10</b>			Order No. 250482
Ammonium	4.00 mg/l NH <sub>4</sub> -N	A6/25 14558	90 90
Chloride	25.0 mg/l Cl	14730	90
COD	80 mg/l COD	C3/25 14540	30 30
Nitrate	2.5 mg/l NO <sub>3</sub> -N	14556 14773	45 60
Phosphate	0.80 mg/l PO <sub>4</sub> -P	P6/25 14543 14848	18 18 9
Sulphate	100 mg/l SO <sub>4</sub>	14548 14791 00617	18 40 48
<b>Model 14675 CombiCheck 20</b>			Order No. 250483
Ammonium	12.0 mg/l NH <sub>4</sub> -N	14544	180
Chloride	60 mg/l Cl	14730	90
COD	750 mg/l COD	C4/25 14541	30 30
Nitrate	9.0 mg/l NO <sub>3</sub> -N	N2/25 14542 14563 14773 14942 09713	90 60 90 60 60 180
Phosphate	8.0 mg/l PO <sub>4</sub> -P	P7/25 14729	90 90
Sulphate	500 mg/l SO <sub>4</sub>	14564	90
<b>Model 14695 CombiCheck 50</b>			Order No. 250486
Ammonium	1.00 mg/l NH <sub>4</sub> -N	14739 14752	19 19
Nitrogen	5.0 mg/l N <sub>ges</sub>	14537 00613	9 9
	20.0 mg/l COD	14560	32

Parameter	Concentration	Compatible test kit model	maximum number of determinations
<b>Model 14696 CombiCheck 60</b>			Order no. 250487
COD	250 mg/l COD	14690 14895	48 48
Chloride	125 mg/l Cl	14897	96
<b>Model 14689 CombiCheck 70</b>			Order No. 250488
Ammonium	50.0 mg/l NH <sub>4</sub> -N	14559 00683	950 480
COD	5,000 mg/l COD	14555	95
Nitrogen	50.0 mg/l N <sub>ges</sub>	14763	95
<b>Model 14738 CombiCheck 80</b>			Order no. 250489
COD	1.500 mg/l COD	14691	48
Nitrate	25.0 mg/l NO <sub>3</sub> -N	14764	190
Phosphate	15.0 mg/l PO <sub>4</sub> -P	14729 P7/25	95 95
<b>Model 18700 CombiCheck 90</b>			Order No. 252501
Cadmium	0.250 mg/l Cd	01745 14834	9 19
Copper	2.00 mg/l Cu	14553 14767	19 19
Iron	1.00 mg/l Fe	14549 14761 00796	19 19 12
Manganese	1.00 mg/l Mn	14770 00816	9 13
<b>Model 18701 CombiCheck 100</b>			Order No. 252502
Aluminum	0.40 mg/l Al	00594 14825	16 19
Nickel	2.00 mg/l Ni	14554 14785	19 19
Lead	2.00 mg/l Pb	14833 09717	19 11
Zinc	0.75 mg/l Zn	00861 14832	9 19

## Standard solutions

Parameter	Conc. [mg/l]	Amount [ml]	Model	Order no.
Aluminum	1000	500	SL Al 19770	250460
Ammonium	1000	500	SL NH <sub>4</sub> 19812	250461
AOX	20	85 (8-16 tests)	AOX 00680	252026
BOD	210	10 Fl. for 10 x 1l	BOD 00718	252030
Boron	1000	500	SL B 19500	250463
Cadmium	1000	500	SL Cd 19777	250464
Calcium	1000	500	SL Ca 19778	250465
Chloride	1000	500	SL Cl 19897	250466
Chromate	1000	500	SL CrO <sub>3</sub> 19780	250468
Chrome	1000	500	SL Cr 19779	250467
COD 100	100	100	SL COD 100	252450
COD 1500	400	30	SL COD 400	252451
Copper	1000	500	SL Cu 19786	250473
Flouride	1000	500	SL F 19814	250470
Iron	1000	500	SL Fe 19781	250469
Lead	1000	500	SL Pb 19776	250462
Manganese	1000	500	SL Mn 19789	250474
Nickel	1000	500	SL Ni 19792	250475
Nitrate	1000	500	SL NO <sub>3</sub> 19811	250476
Nitrite	1000	500	SL NO <sub>2</sub> 19899	250477
Phosphate	1000	500	SL PO <sub>4</sub> 19898	250478
Potassium	1000	500	SL K 70230	252471
Silica (silicon)	1000	500	SL Si 70236	252472
Silver	1000	500	SL Ag 19797	250479
Sulphate	1000	500	SL SO <sub>4</sub> 19813	250480
TOC	1000	100	SL TOC 09017	250499
Zinc	1000	500	SL Zn 19806	250481

List of the standard solutions that required regular fresh preparation due to limited stability:

- free chlorine
- bound chlorine
- formaldehyde
- hydrazine
- hydrogen sulfide
- phenol
- silicon
- sulfide
- sulphate
- anionic tensides
- hydrogen peroxide

## PhotoCheck

**AQA/IQC: comprehensive test equipment for the measurement's optics and linearity!**

The stable color solutions facilitate the checking of the filter and the wavelength settings 445 nm/446 nm, 520 nm/525 nm and 690 nm.

With four solutions per wavelength, the accuracy of the wavelength settings and the linearity of the absorbance measurement are checked. The check takes place quickly and easily via a simple menu-guided function.

## PipeCheck

**Test equipment for the right pipette volume!**

The use of the pipette to be tested leads to the dilution of the relevant test solution with dist. water and compares the absorbance of the diluted solution with the absorbance of a reference solution. Pipettes with variations in volume of more than 2.5% are identified as defective.



## Order information: Test equipment

Model	Description	Order No.
PhotoCheck 14693*	Test equipment for photoLab®	250490
PipeCheck 14962	Test equipment for pipette volumes	250498

\*) also for pHotoFlex upon request

## General instructions

- **Certificates** for test kits marked ■ (coded reagent tests) and ● (coded round cuvette tests) can be found on our homepage at [www.WTW.com](http://www.WTW.com).
- **Storage:** If not stated otherwise, the test kit can be stored at +15 °C to +25 °C .
- We recommend regularly checking reagents and photometers, for example, with **PhotoCheck** and **CombiCheck**.
- Coded round cuvette tests are marked with ●. The external diameter of the cuvette is 16 mm. The round cuvette tests are quick tests with just one measurement range.
- Coded reagent tests are marked with ■. The measurement range specification is based on the total usable measurement range without pre-dilution of the sample and generally includes one (rectangular) cuvette switch.
- All reagent tests require a reaction vessel or RK 14/25 empty cuvettes and rectangular cuvettes.
- Not all cuvette types are recognized for the use of single-use cuvettes; We recommend the use of PMMA cuvettes (250 607).
- The labels "TC" and "TP" stand for test kits suitable for pHotoFlex® without a lot certificate. TCs are round cuvette tests in 16 mm cuvettes, TPs are powder tests and are measured depending on the measurement range in round cuvettes with external diameters of 28 or 16 mm..
- Round cuvettes are not suitable for multiple use.
- For some tests the measurement ranges are provided in a second citation form, for example, nitrate as nitrate (NO<sub>3</sub>) and as nitrate nitrogen (NO<sub>3</sub>-N). Further dimensions and citations forms which can be adjusted can be found in the operating manual for the photometer in use.
- Tests that require a **digestion** , for example, COD, are labeled with the digestion temperature and length (e.g. 148°C, 2 h). The WTW thermoreactors offer suitable programs for this purpose. For digestion, there are crack sets for heavy metals and total nitrogen (*see price list*).
- The current **analysis regulations** are contained in the respective packaging.

*The information for DIN/ISO/EN/US EPA and precise measurement ranges for the photometer models can be found in the price list.*

## Reagent-free tests

### % transmission

0 - 100% T, 10, 20 and 50 mm cuvettes (self absorption).

### Absorbance

Absorbance is proportionally connected with the concentration of a substance held in water as per the Beer Lambert Law  $E = \varepsilon(\lambda) \cdot c \cdot d$ . The proportionality constant  $\varepsilon(\lambda)$  depends on wavelength. These constants and further data, which are required for the determination of the substance contained in water, are stored as method data in modern photometers. The basic measurement size, however, and remains the absorbance.

### Coloring (EN ISO 7887: 1994)

If pure water is viewed under directly transmitted light from a viewpoint of several meters away, it appears to be colored light blue. This coloring can change to a variety of colors in the presence of impurities. Natural waters are usually colored yellowish-brown by iron or clay particles, or by humic substances. (A green coloring may be caused by algae). The "real" coloring of a water sample can be determined following filtration through a 0.45 µm filter.

Usually most yellowish-brown-colored waters and runoff from communal wastewater treatment plants can be measured at 436 nm. The runoff from industrial wastewater treatment plants does not show any steep or pronounced absorbance maximum. To investigate these waters, they must

be measured at 436 nm (quicksilver line), while the other two measuring wavelengths of 525 nm and 620 nm can only deviate slightly from these wavelengths based on the filter used. The standard allows for discontinuous filter photometer measurements with spectral bandwidths from < 20 nm for measurements at 436 nm, 535 nm and 620 nm. Photometers with 445 nm- and 520 nm-interference filters with a bandwidth of 10 nm are therefore also suitable, for example. A spectrophotometer is required for comparison with the standard.

The result is provided in  $m^{-1}$  with the additional display of the measurement wavelengths and the spectral bandwidth, the water temperature, and the pH value. In some publications the result is also provided in CIT (color index transparency), which is identical to the result in  $m^{-1}$ . (DIN ISO 6271: 1988)

Clear liquids: Determination of the color index with the Platinum-Cobalt Scale (Hazen Color Index, APHA Color Index).

Spectrophotometers for the measurement of the stock solution with 430 nm, 455 nm, 480 nm and 510 nm are listed as suitable photometers. The actual measurement takes place as per the standard with a color comparison device enabling a visual comparison.

### Chrome bath

Reagent-free measurement of the self-coloring of a galvanizing bath: Pipette in a 5 ml sample to a 100 ml graduated cuvette, fill up to the mark with distilled water and mix well. Pipette in 4 ml of the diluted sample to a 100 ml graduated cuvette, fill up with distilled water and mix well. Add 5 ml of the 1:500-diluted sample to a glass with a screw top, add 5 ml 40% sulfuric acid. Seal the glass and mix the contents well. Decant into a rectangular cell for measurement

### Nickel bath

Reagent-free measurement of the self-coloring of a galvanizing bath: Fill a 5 ml sample with 5 ml 40% sulfuric acid in a round cuvette, seal and mix. Decant into a rectangular cell for measurement

### Copper bath

Reagent-free measurement of the self-coloring of a galvanizing bath: Add a 25 ml sample to a 100 ml

graduated cuvette, fill up to the mark with distilled water and mix well. Add 5 ml of the diluted sample to a glass with a screw top, add 5 ml 40% sulfuric acid. Seal the glass and mix the contents well. Decant into a rectangular cell for measurement

### SAC - spectral absorption coefficient

The spectral absorption coefficient is generally designated as SAC (unit 1/m) and photometrically determined as the sum of the dissolved organic substances contained in the water. In the area of drinking water, the SAC is usually measured at a wavelength of 436 nm, and at 254 nm in the wastewater sector. In doing so, differentiation must be made between clear and turbid samples. To be noted as a limitation is the fact that this summary determination can only be sensibly applied if the qualitative composition of the substances contained in the water does not significantly change. SAC methods are available in the photoLab® 6000/7000 Series.

### Further application methods for photoLab® 6000/7000

Application methods are photometric procedures usually based on completed test kits and which usually require multi-level steps. The selection of application methods is carried out manually via the input of the method number. A complete list of the programmed procedures can be found in the photometer's analysis regulations.

- ADMI color measurement
- Chlorophyll-a as per DIN
- Chlorophyll-a as per ASTM
- Chlorophyll-a, -b, -c as per ASTM
- Glucose
- TSS (total suspended solids)

# Turbidity measurement

Неварреактив



---

## Content

165 *Applications and meters overview*

166 *Turbidity measurement - A parameter for quality control*

168 *Mobile turbidity meter with laboratory quality*

# Application areas and meters overview

The turbidity of a sample is a subjective perception and in shows variable effects in contrast to electrochemical or physical parameters. It is based on particles that are dispersed in a solution, of different sizes, differently shaped and movable. Turbidity measurement serves as a quality and indicator parameter in many applications.

- yes
- ✓ yes
- not recommended/not present

Applications	Turb® 430 IR	Turb® 430 T	Turb® 355 IR
Turbidity in drinking water as per EN ISO 7027	●		●
Turbidity in drinking water as per US EPA 180.1		●	
Official monitoring	●	●	●
Environmental monitoring	●	●	●
Industry, quality control with IR 860 nm	●		●
Industry, quality control with halogen 560 nm		●	
Service laboratories, mixed applications	●	●	●
Field applications and mobile QC	●	●	
<b>Properties</b>			
Standard measurement < 1 NTU	✓	✓	–
AMCO Clear® calibration standards	✓	✓	✓
AQA with documentation/protocol	✓	✓	–
Calibration interval	✓	✓	–
Data management PC software LSdata (on request)	✓	✓	–
LIMS connection via LSdata	✓	✓	–
PC port	✓	✓	–
Battery/battery packs	✓/✓	✓/✓	✓/–
Data memory	✓	✓	–
Software methods update	✓	✓	–
Standalone instrument / LabStation (as laboratory solution, optional)	✓/✓	✓/✓	–/–
Carrying case kits	✓	✓	✓
	<b>Turb® 430 IR</b>	<b>Turb® 430 T</b>	<b>Turb® 355 IR</b>
see page	169	169	170

# Turbidity measurement: A parameter for quality control

In quality monitoring, the measured value "turbidity" is a meaningful indicator parameter. This applies e.g. for drinking water treatment, where the number of particles must be less than 1 NTU as a possible base for bacteria. In beverage production, in the chemical industry, in the production of vaccines or even fuels for engine development, turbidity is a quality control with "in-house" limit value definitions.

Undissolved solids in liquid, as e.g. algae, sludge, microbes or other particles, absorb and scatter light passing through. As the number of particles increases, the turbidity degree also increases noticeably for our eyes. The shape, size and composition of the particles influence the degree of turbidity. The measurement of the scattered light at a 90 ° angle has proven to be superior, especially in the low measuring ranges, and is therefore standard for measuring in drinking water control.



## Various standard specifications for drinking water monitoring

There are different types of measuring instruments that differ with respect to the light source: For standard-compliant measurements in accordance with ISO 7027 / DIN EN 27027 (EN ISO 7027), an IR LED (infrared) with a wavelength of 860 nm is required. The Standard Methods for the Examination of Water and Waste water / US EPA require a tungsten broadband light source ("white light").

## Infrared or white light depending on the application

For applications without standard specifications, the optimum solution is sought. As the turbidity measurement is often used for quality control, the measurement should be carried out in a previously internally defined measured value window.

- Infrared (IR) light sources minimize or eliminate the influence of coloring in a solution, as at the wavelength of 860 nm virtually no absorption takes place. It is therefore particularly advantageous for colored solutions. The detection sensitivity for small particles is somewhat lower at this wavelength due to the generally lower scattering of small particles.
- White light has a higher sensitivity for small particles, on the other hand an intrinsic coloring of the solution has a reinforced disturbing factor.

## Various measuring methods

Especially in the field of industrial quality control, different methods are used: In addition to the nephelometric measurement with 90 ° scattered light for low turbidity values, the transmitted light method at 180 ° is advantageous for medium and higher turbidity, as the scattered light and the shadow effect between the particles increases with increasing turbidity and the decrease of the light intensity provides a more accurate result.

Depending on the manufacturer or industry, the ratio method measures at different angles and calculates the results. There is no single standard for this.



Turbidity measuring cuvette and standard cuvette

## AMCO Clear® turbidity standards

- **±1% Production accuracy**
- **High precision and long-term stability**
- **Does not pose a health hazard**
- **Easy to dispose of**

The calibration of turbidity meters is based on the reproduction of differently sized and shaped particles in the real world. The turbidity standards AMCO Clear® for Turb® instruments are polymeric calibration standards with a defined particle composition and are distinguished from formazine by significantly higher result accuracy and stability without drift behavior. The conventional formazine standards with a tolerance of 5-10% are compared with the production accuracy with regard to the particle composition of 1%. They are batch-certified and N.I.S.T. traceable to formazine.

The standards are optimally matched in the particle composition to the respective instrument optics and are particularly well suited for applications in the lowest measuring range such as drinking water.



AMCO Clear turbidity standards



# Mobile turbidity meter with laboratory quality Turb® 430 IR/Turb® 430 T

The Turb® 430 series turbidity meters are equally well suitable for portable and laboratory use due to their accuracy and laboratory comfort. They cover the measuring range of 0.02-1100 NTU / FNU for nephelometric measurements with 90 ° scattered light.

Turb® 430 IR fulfils the requirements of DIN 27027/ISO 7027, Turb® 430 T those of US EPA 180.1. The turbidity meters are characterised by many extras:

- Intuitive operation with menu navigation
- Automatic measuring range switching
- Simple and high precision calibration
- AQA by means of calibration protocol and calibration interval adjustment
- 1000 data sets can be stored
- Sample identification number (ID)
- Scattered light behaviour as per Pharmacopoeia 9
- Data output
- Optional PC software LSdata for convenient data management (see page 175)

Turb® 430 turbidity meter with AMCO Clear® turbidity standards

- **Highest precision from 0.02 NTU**
- **Accoring to DIN/EN ISO and US EPA**
- **AQA with GLP-complying documentation**

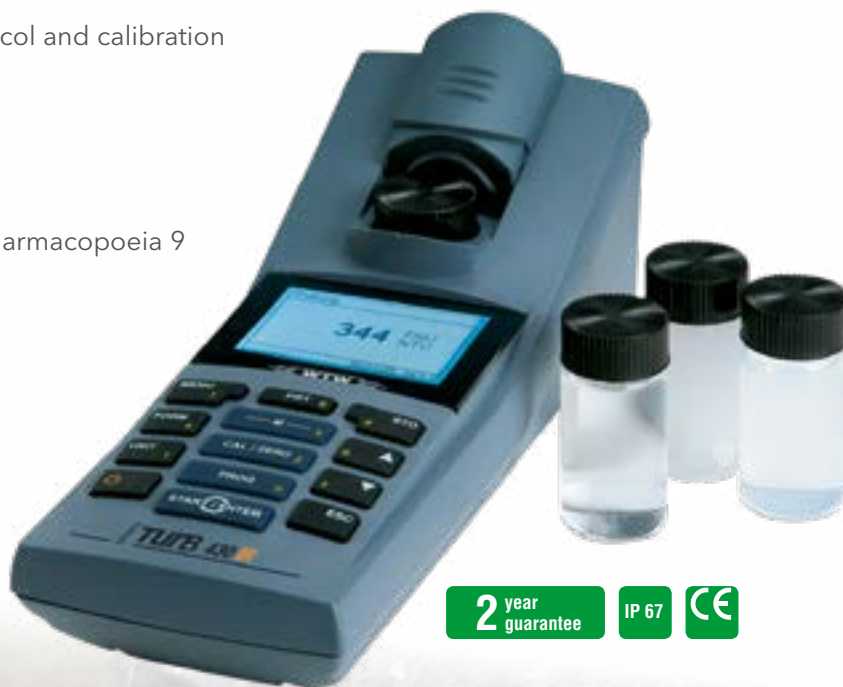

2 year guarantee IP 67 CE



## Portable turbidity measurement with the Turb® 430 Series

- **Mobile Laboratory quality**
- **Safe working on site**
- **GLP-compliant documentation**

For the mobile monitoring of the drinking water quality of wellheads, cisterns and springs or for environmental monitoring and measurement at various production sites, there is the practical carrying case kit with a small "laboratory table", battery pack and the PC software LSData for data management.



The mobile turbidity laboratory - the carrying case kits for Turb® 430 IR/T

## Turbidity measurement in the laboratory with the Turb® 430 Series

- **Highest precision**
- **Data memory and sample ID**
- **Documentation via PC software LSdata (see page 175)**
- **Optional LabStation**

The precision optics together with the long-term stable calibration through the AMCO Clear® turbidity standards and GLP-compliant documentation make the Turb® 430 series the ideal partner for service laboratories, health authorities and manufacturing industry, wherever mobile as well as laboratory use is required.



Turb® 430 turbidity meter with LabStation in mineral water industry

## Turb® 355 T / Turb® 355 IR

- 0 - 1100 NTU/FNU
- Simple operation
- Quality control > 1 NTU



Turb® 355 IR/T field case set



### Small, portable turbidity meters

Battery-powered turbidity meter with Infrared LED (860 nm) for nephelometric measurements in accordance with ISO 7027/DIN EN 27027 (EN ISO 7027) or as white light model with tungsten lamp in accordance with US EPA.

It is handy, light and very easy to use.

The Turb® 355 IR/T is supplied as a kit in a small carrying case, which contains all necessary accessories (calibration standards 0.02 - 10.0 and 1000 NTU, empty cuvettes and batteries). The instrument operates with 4 MICRO (AAA) Alkali manganese batteries.

## Technical specifications: Turbidity meters

	Turb® 430 IR / Turb® 430 T	Turb® 355 IR / 355 T
<b>Measurement principles</b>	Nephelometric (90° scattered light)	Nephelometric (90° scattered light)
<b>Light source</b>	IR LED / Tungsten lamp	IR-LED/Tungsten lamp
<b>Measuring ranges</b>	<b>NTU</b> 0,02 - 1100 / 0 - 1100 <b>FNU</b> 0.02 - 1100	0 - 1100 0 - 1100
<b>Resolution</b>	0.01 for the range 0.00 - 9,99 0.1 for the range 10 - 99,90 1 for the range 100 - 1100	0.01 NTU in the range 1 - 9.99 0.1 NTU in the range 10.0 - 99.9 1 NTU in the range 100 - 1000
<b>Accuracy</b>	0.01 NTU or ±2 % of the measured value	±2 % of the measured value or ±0.1 NTU last decimal point in the range 1 ... 500 NTU ±3% of the measured value in the range 500 ... 1100 NTU
<b>Repeatability</b>	<0.5 % of the measured value or 0.01 NTU/FNU	±1% of the measured value or ±0.05 NTU/FNU
<b>Calibration</b>	Automatic 3 point calibration	Automatic 1...3 point calibration
<b>Response time</b>	Approx. 3 seconds (IR) / approx 7 seconds (T)	14 seconds
<b>Cuvette</b>	28 x 60 mm, 20 ml sample volume	25 x 45 mm, 15 ml sample volume
<b>Interface</b>	RS 232, USB via adapter	
<b>Particular calibration protocol</b>	Yes	-
<b>Functions Measured value memory</b>	1000	-
<b>RS 232</b>	Yes	-
<b>Date/time:</b>	Yes	-
<b>Data evaluation</b>	Yes	-
<b>Battery</b>	optional	-
<b>Operating temperature</b>	0 - +50 °C	0 - +50 °C
<b>Power Supply</b>	4 Mignon (AA) for approx. 3000 measurements	4 MICRO (AAA) Alkaline batteries sufficient for more than 1,500 measurements

## Order information: Turbidity meters

Model	Description	Order no.
<b>Turb® 355 IR</b>	Portable meters a carrying case as per ISO 7027 / DIN EN 27027 (EN ISO 7027), with 3 calibration standards 0.02 - 10.0 - 1000 NTU	600311
<b>Turb® 355 T</b>	as Turb® 355 IR, but with tungsten light source as per US EPA 180.1	600312
<b>Turb® 430 IR</b>	Portable turbidity meter for nephelometric measurements (90 °) according to DIN EN 27027, incl. calibration kit 0.02 - 10 - 1000 NTU, suitable for drinking water	600320
<b>Turb® 430 T</b>	as Turb® 430 IR, but with tungsten light source as per US EPA 180.1	600325
<b>Turb® 430 IR/SET</b>	Portable turbidity meter (90 °) with infrared light source as per DIN EN 27027 in a field carrying case with table insert, calibration set 0.02 - 10.0 - 1000 NTU and accessories	600321
<b>Turb® 430 T/SET</b>	as Turb® 430 IR/SET, but with tungsten light source as per US EPA 180.1	600326

For additional products, sets, and accessories, see price list or [www.WTW.com](http://www.WTW.com)



# Software, documentation



---

## Content

173	<i>MultiLab Importer</i>
173	<i>MultiLab User</i>
174	<i>ACHAT OC</i>
174	<i>photoLab® Color</i>
174	<i>photoLab® Data spectral</i>
175	<i>LSdata</i>

# Software and data documentation

Documentation of measurement data for the storage and, further processing, is an important task to be completed. Tailor-made programs for each product are available:

## MultiLab® Importer

**For the transfer of measurement data incl. sensor and instrument parameters to Excel®; for MultiLine®, ProfiLine and inoLab® meters**

The MultiLab® Importer is a free Excel® add-in for the simple transfer of measurement values

- Automatic recognition of the connected device
- Structured data structure for quick processing
- Clear documentation of the calibration protocol via text fields

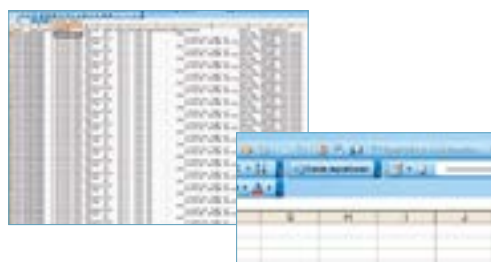

Software screenshots

## MultiLab® User

**For setting up user administration; for all current MultiLine® or inoLab® Multi IDS meters (Multi 3510 IDS, 3620 IDS, 3630 IDS, inoLab® Multi 9310 IDS, 9620 IDS, 9630 IDS)**

- User administration setup as per GLP/GMP guidelines
- Up to 50 users with password possible
- Three access levels with different authorizations
- Password-protected administrator access
- Traceability through the allocation of measurement data/ users
- For Multi 3620 IDS, 3630 IDS, inoLab® Multi 9620 IDS and 9630 IDS: Individual digital designation of IDS sensors possible



## ACHAT OC

### For the recording of measurement data; for OxiTop® Controller OC 100 or OC 110 (free download)

The Achat OC is a program compatible with the most recent PC environments for the recording of data from the OxiTop® Control systems. With a redesigned interface, it presents the data clearly and ensures the export in \*.csv format.

- Import of all data from the controller
- Export for processing in Excel or CSV format
- Simple data transfer with one mouse click



## photoLab® color – color measurement instead of color perception

### For PC-controlled color measurement; for photoLab® 7100 VIS and 7600 UV-VIS

photoLab® color offers a clear and intuitive user interface for multiple measurements, method switches, and direct data management and printouts of the measuring results.

- CIE color measurement XYZ, x,y,z, CIE-L\* a\* b\*,
- CIE-L\* u\* v\*
- Hazen (Pt-Co)
- Yellowness index
- ADMI color number
- ASTM
- Gardner
- Sugar color ICUMSA
- Beer color as per EBC and ASBC
- Iodine color number



Software screenshots

## photoLab® Data spectral

### For simple data management; for the photoLab® 6000/7000 Series

- GLP-compliant data management
- Convenient data transfer from measurement instrument to the PC for processing (e.g. with LIMS, XLS, CSV)
- Export of spectra in specialist software for the comprehensive display and processing of spectra
- Conciliation of methods, profiles and meter updates in several photometers



# LSdata

## Simple data management for the photoFlex® and Turb® 430 Series

The LSdata PC software for photoFlex®/Turb® 430 meters offers a clear interface for:

- GLP-compliant data transfer (CSV/Excel format)
- The creation and management of user-defined methods via a clear dialog window
- Automatic calculation of the calibration curve for custom-defined methods, method reconciliation between PC and meter(s)
- Documentation of calibration protocols



## Overview meters software/connection cable PC or printer

MI = MultiLab® Importer    Mp = MultiLab® pilot    AO = ACHAT OCMA = Multi/ACHAT II    pDS = photoLab® Data spectral    LS = LSdata  
 b = bidirectional    r = remote-controlled    u = unidirectional

meter	Software	Connection cable	Type
inoLab® pH 7310	MI	AK USB A-Mini	b
inoLab® Oxi 7310	MI	AK USB A-Mini	b
inoLab® Cond 7310	MI	AK USB A-Mini	b
inoLab® pH/ION 7320	MI	AK USB A-Mini	b
inoLab® Multi 9310 IDS	MI	AK USB A-Mini	b
inoLab® Multi 9420 IDS, 9620 IDS	MI	AK USB A-Mini	b
inoLab® Multi 9430 IDS, 9630 IDS	MI	AK USB A-Mini	b
pH 3310	MI	AK USB A-Mini	b
Oxi 3310	MI	AK USB A-Mini	b
Cond 3310	MI	AK USB A-Mini	b
pH/Cond 3320	MI	AK USB A-Mini	b
Multi 3320	MI	AK USB A-Mini	b
pH 3310 IDS	MI	AK USB A-Mini	b
Oxi 3310 IDS	MI	AK USB A-Mini	b
Cond 3310 IDS	MI	AK USB A-Mini	b
MultiLine® IDS: Multi 34x0, Multi 3510 IDS, Multi 3620 IDS, Multi 3630 IDS	MI	AK USB A-Mini	b
pHotoFlex® Series	LS	AK 540 B, ADA USB	u
photoLab® S6, S12	MA	AK Laboratory	b
photoLab® 6000/7000 Series	pDS	Standard cable	b
Turb® 430 Series	LS	AK 540 B, ADA USB	u
OxiTop® OC 100/110	AO	AK 540 B	u

meter (discontinued)	Software	Connection cable	Type
pH 340i	Mp	AK 340/B	b
Oxi 340i	Mp	AK 340/B	b
Cond 197i, 1970i	Mp	AK 340/B	b
Cond 340i	Mp	AK 340/B	b
pH 197i, 1970i	Mp	AK 340/B	b
pH/Cond 340i	Mp	AK 340/B	b
pH/ION 340i	Mp	AK 340/B	b
pH/Oxi 340i	Mp	AK 340/B	b
inoLab® 730	Mp	AK 340/B	b
inoLab® 735	Mp	AK 340/B	b
inoLab® Level 2	Mp	AK 340/B	b
Multi 197i, 1970i	Mp	AK 340/B	b
Multi 340i	Mp	AK 340/B	b
Multi 350i	Mp	AK 340/B	b
Oxi 197i, 1970i	Mp	AK 340/B	b
Oxi 3315	MI	AK USB A-Mini	b

Note:  
 USB adapter without cable for meters with RS232 interface available; meters-compatible cable required.

## Order information: Software

Item	Description	Order No.
<b>KOM pilot</b>	Communications package, consisting of: 1 x MultiLab® pilot and one AK 340/B connection cable	902915
<b>photoLab® color + photoLab® Data spectral</b>	PC software for color measurement and for simple data management	902763
<b>LSdata</b>	PC software for pHotoFlex®/Turb® 430 Series	902762
<b>Multi/ACHAT II</b>	Software for PC in Windows, German and English	902750
<b>AK Labor</b>	Communications package, consisting of: 1 x Multi/ACHAT II and 1 AK Labor	902754
<b>AK Adapter</b>	USB adapter to serial interface RS 232 (9-pin socket)	902880

For connection cables/further accessories see price list



# Services/ certificates



---

## Content

- 177 IQ/OQ/PQ qualifications
- 178 Certifications
  - 179 Available cost free certificates
  - 179 Calibration certificates available for a fee
- 180 About us
- 182 [www.wtw.com](http://www.wtw.com) - News around the clock
- 182 Important notes
- 183 Index

# Certified, traceable reagents

Measurements are naturally afflicted with errors. This particularly applies for the calibration of meters and sensors. To be able to quantify these errors you have to indicate the deviation of the measurement value in comparison to national or international standards. In a figurative sense, these are the "original meter" for the relevant measurement sizes.

In chemical analysis reference materials are used which are measured by metrological equipment. The uncertainty of the measurement value for any such material is documented. Such institutes include, for example, the National Institute of Standards, NIST, Gaithersburg USA) and the Physikalisch-Technische Bundesanstalt (PTB, Braunschweig).

Comparative measurements in further stages derive secondary, tertiary, etc. materials from the primary reference materials. Each stage sees uncertainties in relation to the "original meter" which meets the requirements of the measurement equipment and procedures. It is important that the calibration of a measurement system can be traced back in an unbroken chain with defined uncertainty to the relevant standard.

In practice, work reference buffer solutions are used, which are obtained by comparison with primary or secondary material. WTW pH buffers meet these needs. Certificates document the respective uncertainty of the pH value of the solution.

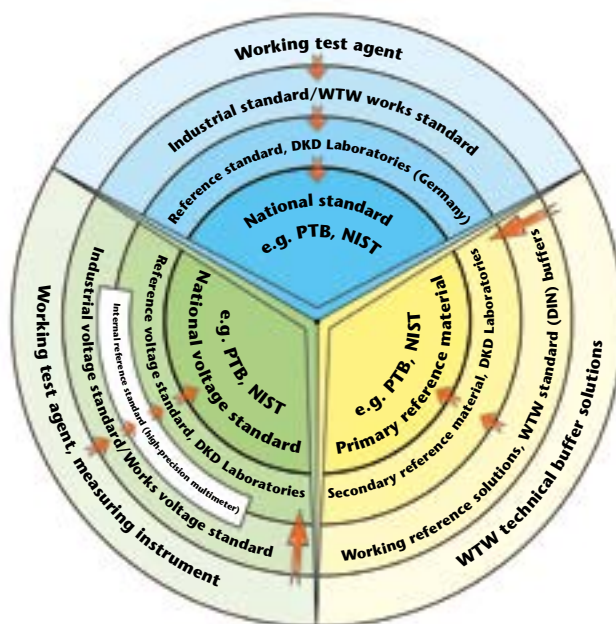

# IQ/OQ/PQ qualifications

Xylem Analytics Germany offers the qualification of measurement systems, particularly for the pharmaceutical industry. The basis for this is the design qualification based on the requirements for the measurement system. Here the customer states what they would like to measure, in what environment, and how this measurement task should be fulfilled.

Following the selection of a suitable system, Xylem Analytics Germany can, upon request, provide documentation for the qualification of the system on-site. This will be carried out by one of our employees following on a mutually arranged date.

In the **Installation Qualification (IQ)** the scope of supply is checked for completion and appropriateness and attention is paid to compliance with the environmental conditions. The documentation is prepared via a pre-printed record to be signed.

The **Operational Qualification (OQ)** helps monitor the correct functioning of the meter under the conditions specified. The calibrations carried out for it have the advantage that the

measurement values can be checked against certified reference materials (exception: dissolved oxygen). Here too the results are recorded.

For the **Performance Qualification (PQ)** the customer receives appropriate templates from us which they can generally use for two requirements: for routine monitoring on the one hand, and for a fault procedure on the other. In addition, they can copy the templates provided as much as necessary.

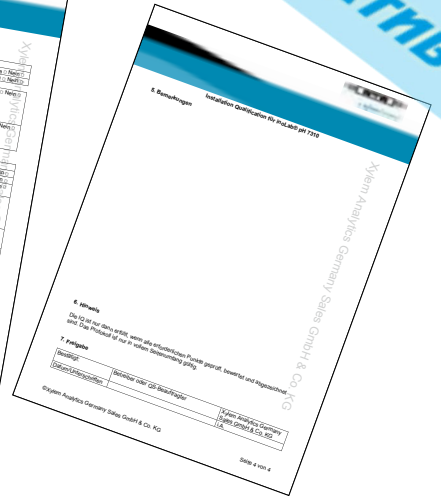
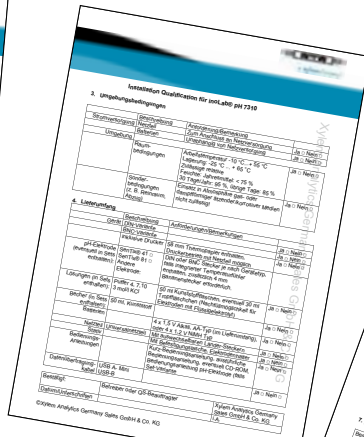
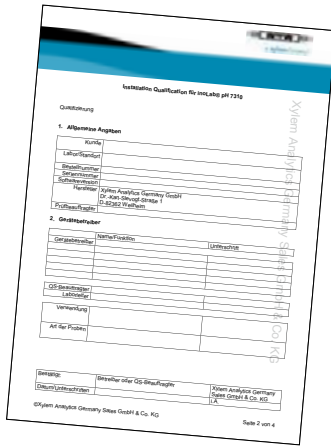
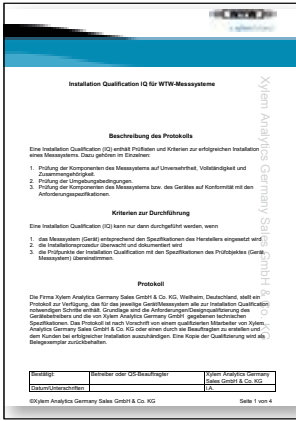

Xylem Analytics Germany offers IQ/OQ/PQ documentation for the following WTW meters inoLab® 7110, 7310, 9310 IDS, 9620 IDS, 9630 IDS, 7320 (pH only). MultiLine® IDS upon request.

# Certifications

Calibration of measurement systems for the determination of conductivity, pH value and oxygen released in aqueous solutions

## The certification per DIN ISO 9001 assumes test equipment monitoring

The correct functioning of the test equipment used is a set prerequisite for the accuracy and comparability of measurement values. As a result, regularly monitoring the precision of every test equipment after a set period of use alongside a calibration counts as one of the primary rules of **quality assurance** and **good laboratory practice**.

This is a task facing a constantly growing number of businesses and laboratories which are aiming for or have already achieved the certification of their QA system as per the DIN ISO 9001 series of standards.

## Why you should use the manufacturer's specialist knowledge

Specially-qualified staff with specific knowledge of the relevant meters are required for correct calibration and suitable calibration means must be used. As a result it is usually more efficient and more economical to have an inspection of test equipment carried out by an external calibration laboratory or even by the manufacturer.

We are here for you as a competent partner and can carry out this service for all WTW measurement systems for the determination of pH value, conductivity and dissolved oxygen.

We have been ISO 9001-certified since 1993 and are experts of the standard's requirements. Our calibration devices conform with national standards. Calibration equipment for which no national norms exist are manufactured in accordance with acknowledged national and international standard procedures.

We can carry out a manufacturer calibration and provide you a calibration certificate.

If required, we can also carry out the inspection of test equipment for our photometers and BOD meters. We are happy to advise you.

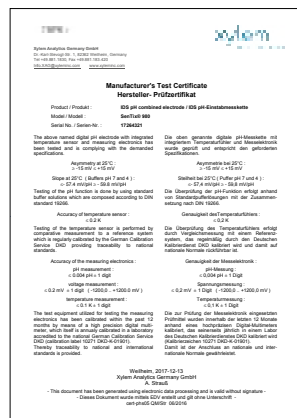
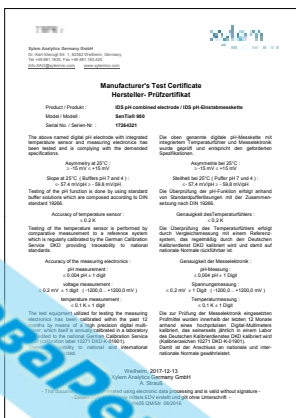

## Freely available certificates (Certificates available free of charge)

### Certificate of compliance

General certificate (without provision of a serial number) certifying that the product conforms with the technical data laid down in the operating manual. The certificate does not carry a signature and is free of charge.

### Manufacturer's test certificate

Individual certificate (with provision of the serial number) stating that the product has been checked and the accuracy specifications listed in the certificate have been fulfilled. Contains a passage regarding the regular calibration of the test equipment used by us and its traceability as per national and international standards. Provides the customer as proof for the purposes of the ISO 9001.

### Certificates for brand new products:

These certificates are provided for all meters. The certificate does not carry a signature and is free of

charge. If required, it can be obtained from us up to three months after the purchase of the meter or sensor.

### CE conformance declarations

Declaration of the product's conformity with the applicable EU guidelines.

### Manufacturer's certificate for calibration solutions

For the pH buffer solutions and the conductivity calibration solutions offered in our product range, upon ordering or within 3 months of purchase we can issue a manufacturer's certificate in which the controlled manufacture is certified on the basis of national or international standards.

## Calibration certificates with additional costs

### Calibration certificates for meters

The meter's measurement functions are calibrated independently of the sensor under the use of electrical standards.

### Calibration certificate for sensors

The calibration will be made with pH electrodes and conductivity-cells by using calibration solutions. For dissolved oxygen sensors, the slope is calibrated using vapor-saturated air and the zero current will be calibrated with a zero solution or pure nitrogen.

pH electrodes and dissolved oxygen sensors are underlying a slow altering of their specifications ("ageing"). As a result, these must be re-calibrated by the user at regular intervals, as described in the operating manual of the corresponding meter.

### Certificates for used products

Upon customer request, in connection with a repair order. Test dates are stored in a record. The certificate is signed by QM representatives and invoice

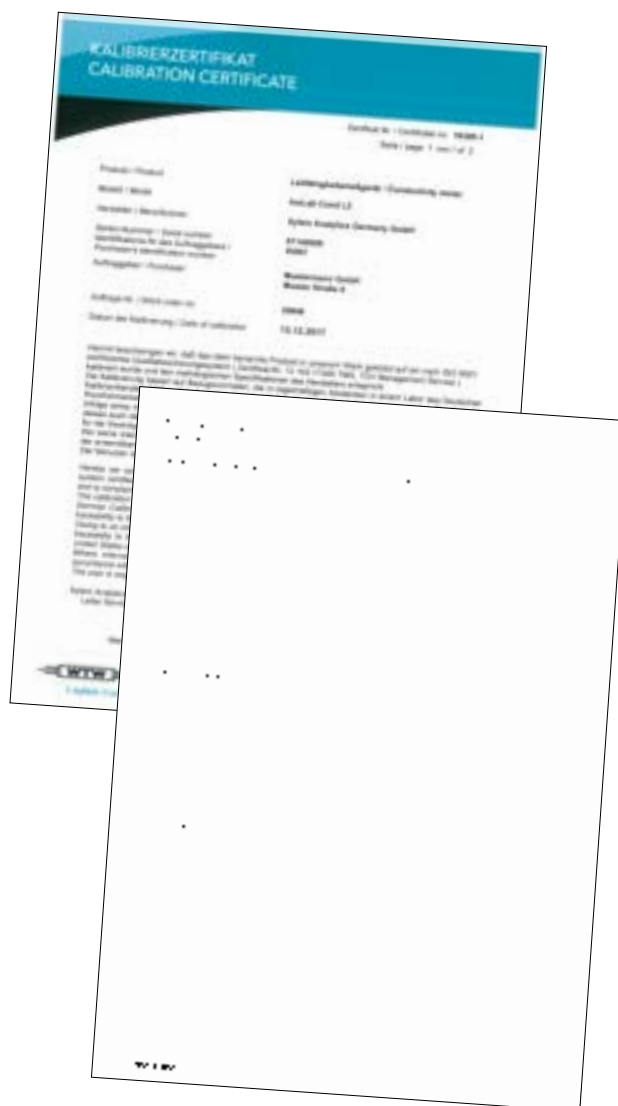

Highlights	
1954	Introduction of the first WTW pH meter
1965	Introduction of the first WTW oxygen sensor
1982	Introduction of the first zero current-free (zero point-stable) dissolved oxygen sensor in the world for field measurements
1983	Introduction of online measurement technology
1986	First provider of a 3-electrode dissolved oxygen sensor (TriOxmatic®) with fully automated precision air calibration (OxiCal®)
1987	First provider of a 4-electrode conductivity sensor (TetraCon®) for water analysis
1993	First ISO 9001-certified manufacturer of O <sub>2</sub> , pH, conductivity measurement systems
1995	<ul style="list-style-type: none"> <li>• Introduction of the mercury-free system, <b>OxiTop®</b> for BOD determination.</li> <li>• First global provider of transmitters with integrated lightning protection</li> </ul>
1997	The new <b>photoLab®</b> laboratory photometers combine exemplary technical measurement precision with ease of use
1998	<ul style="list-style-type: none"> <li>• With the <b>PurCon®</b> sample preparation system WTW succeeds in the replacement for traditional filtration systems</li> <li>• First WTW spectrophotometer</li> </ul>
1999	The new laboratory meters from the <b>inoLab®</b> family set new standards in the measurement of pH, O <sub>2</sub> , conductivity, ISE and temperature
2000	Introduction of <b>TresCon®</b> , the modular analysis system for the continuous measurement of ammonium, nitrite, nitrate, phosphate
2001	<ul style="list-style-type: none"> <li>• <b>IQ SENSOR NET</b> - the multi-parameter measurement system offers unlimited possibilities for online measurement</li> <li>• The new <b>VisoTurb®</b> and <b>ViSolid®</b> turbidity and TSS (total suspended solids) sensors, with their revolutionary ultrasound cleaning system, bring a whole new dimension to "low-maintenance"</li> </ul>
2002	• <b>AmmoLyt® 700 IQ</b> facilitates reliable online "in-situ measurement" of ammonium
2003	<b>NitraLyt® 700 IQ</b> expands the AmmoLyt® with an additional nitrogen parameter (nitrate) in online "in-situ" measurements
2004	<ul style="list-style-type: none"> <li>• The multi-parameter <b>Multi 350i</b> instrument sets standards for portable meters.</li> <li>• The spectral sensors <b>NitraVis®</b>, <b>CarboVis®</b> and <b>NiCaVis®</b> are introduced for online carbon, nitrate, and suspended solids measurements in wastewater</li> </ul>
2005	<ul style="list-style-type: none"> <li>• Portable photometers and turbidity meters for universal use: <b>pHotoFlex®/pHotoFlex® Turb/Turb 430 IR</b></li> <li>• IQ SENSOR NET System 182 - the compact 2-channel measurement system</li> </ul>



a xylem brand

## About us

As a brand of Xylem Analytics Germany GmbH, rich in tradition, we see our task in using our expertise and innovative technologies to find solutions for our customer's measurement tasks.

You can find out more about Xylem on our website: [www.xyleminc.com](http://www.xyleminc.com)

### Laboratory and field meters

With the slogan "We supply know-how", our more than 70 years of experience have resulted in a comprehensive product range of pH, ORP, conductivity, oxygen/BOD/respirometric and turbidity meters as well as photometers with reagents. The product range includes both robust, waterproof portable meters and modern laboratory meters with versatile accessories. A variety of multi-parameter instruments made with state-of-the-art technology cover a wide spectrum of measurement parameters for laboratory and field applications.

The WTW IDS sensors convert the measurement values within the sensor directly into fail-safe digital signals and transfer these to the connected meters, guaranteeing a maximum level of precision and security. As a result they form the core of a comprehensive system of digital MultiLine® portable and inoLab® laboratory meters.

We have taken the further step of using wireless modules to make the IDS system independent of sensor cables. The new MultiLine® and inoLab® meters therefore represent the state-of-the-art in electrochemical measurement technology.

We also offer top technology with our optical systems in the form of the spectrophotometers of the photoLab® 7000 Series for the UV and VIS range.

### Online systems

For many years the IQ SENSOR NET has been a technology leader in wastewater quality measurement. It can be used both as single on-site measurement and in a network.

Here too the innovative digital sensors represent the heart of the system. As a result the IQ SENSOR NET is the most flexible digital multi-parameter system for one to 20 measurement points.

With the new MIQ/MC3 controller family with integrated USB and LAN interfaces, the IQ Sensor Net System is expanded to internet communication via TCP/IP technology.

### Service

With over more than 70 years of existence, the WTW brand has established a first-class reputation through its exemplary customer-support. Our Care Center is ready to find an individual solution for any customer's measurement problems. WTW's comprehensive application collection, in connection with expert application specialists, ensures fast solutions for technical challenges. The dealer and service network extends around the world.

As before, the largest percentage of our products are produced at our facility in Weilheim in Upper Bavaria, south of Munich, by nearly 400 employees - quality-measurement technology with expert support, "Made in Germany".

Highlights	
2006	<ul style="list-style-type: none"> <li>• <b>VARiON®</b> multisensor for ammonium and nitrate with dynamic compensation</li> </ul>
2007	<ul style="list-style-type: none"> <li>• The new optical online dissolved oxygen sensor <b>FDO® 700 IQ</b></li> <li>• The new spectrophotometers of the <b>photoLab® 6000</b> Series combine systematic and spectral analysis with proven AQA quality assurance</li> </ul>
2008	<p>Further development of the IQ SENSOR NET system:</p> <ul style="list-style-type: none"> <li>• New <b>TC 2020 XT</b> terminal/controller with USB and dual-processor function</li> <li>• <b>System 182 XT-4:</b> for up to four sensors</li> <li>• <b>IQ LabLink</b> combines online measurement with laboratory calibration</li> </ul>
2009	<p>The new <b>ProfiLine</b> single parameter portable meters offer the highest levels of robustness and ease of use</p>
2010	<p><b>MultiLine® IDS</b> - the new digital world:</p> <ul style="list-style-type: none"> <li>• <b>MultiLine®</b> - the digital multi-parameter portable meters and</li> <li>• <b>FDO® 925</b> - the new optical dissolved oxygen sensor for field and laboratory</li> </ul>
2011	<p><b>inoLab® Multi IDS</b> - IDS technology for the laboratory</p>
2012	<ul style="list-style-type: none"> <li>• <b>MPP-IDS</b> multi-parameter depth sondes for digital IDS sensors and portable meters</li> <li>• UV-VIS sensors - the next generation: <b>CarboVis®, NitraVis®</b> and <b>NiCaVis®</b> with new optics, integrated ultrasound cleaning and high-tech materials</li> <li>• <b>IFL 700 IQ</b> sensor - sludge-level measurement for sludge management in wastewater treatment plant</li> </ul>
2013	<p>UV-VIS sensors for nitrite measurement: <b>NiCaVis®-NI</b> and <b>NitraVis®-NI</b>.</p>
2014	<ul style="list-style-type: none"> <li>• Expansion of the digital <b>IDS sensor</b> range - with fixed cable or with plug head</li> </ul>
2015	<ul style="list-style-type: none"> <li>• <b>OptRF</b> - the reagentfree photometric determination of COD, NO<sub>3</sub>, NO<sub>2</sub> with <b>photoLab® 7600 UV-VIS</b></li> <li>• Digital transmitter with fixed-cable sensors for individual measurement points <b>System 182</b></li> </ul>
2016	<ul style="list-style-type: none"> <li>• IDS goes wireless: <b>IDS wireless modules</b> enable the wireless transfer of measurement data from IDS sensors to wireless ready IDS laboratory and portable meters.</li> <li>• A new mid-range segment model is introduced to the IQSN system with the <b>System 282/284</b></li> </ul>
2017	<p>The new <b>MIQ/TC 2020 3G</b> terminal/controller inspires amazement with its large, color display, automatic measurement value storage, and simplified maintenance, which is even possible remotely via IQ Web Connect.</p>

# www.wtw.com - News around the clock



## New products

Take a look: Here you can find new products, developments, innovative measurement and analysis instruments, helpful accessories, useful system extensions, special sets, and much more.

## Applications

On our website you will find the solution to your measurement tasks in research, analysis and quality control - and additionally many application.

## Downloads

Are you looking for an operating manual, application report, or do you need a certificate? Everything is provided for you in our download area.

## Contact addresses

Looking for a contact in your area? Find our national and international contact persons, representatives and addresses here.

## Offers

You can find constantly updated special offers in our offers section.

## Our newsletter

Get the latest updates, product information, offers and news on services: register for the WTW newsletter on our website. Appears around 6 time/year.

## Important notes

### General information

1. Customized meters upon request.
2. Please request accessories and replacement parts for older meter models separately.
3. To spare our customers from minimum order surcharges, we deliver consumables in tried and tested minimum amounts.

### Technical modifications

The technical descriptions correspond to the products current state. Modifications due to technical advances are possible.

### Figures

We would like to note that the figures are for illustrative purposes. Deviations from the description and figure are therefore possible.

### Liability

No liability can be taken for printing errors, typographical errors, or transmission errors in this catalog.

Printed January 2018





# Index

<b>L</b>		PL6-BREW.....	140	SL COD 100.....	161
LR 325/01.....	107	PL 7.....	69	SL COD 400.....	161
LR 325/001.....	107	PL 9.....	69	SL Cu 19786.....	161
LR 925/01.....	35	PO4-1 TP.....	157	SL F 19814.....	161
LR 925/01-P.....	35	PO4-2 TC.....	157	SL Fe 19781.....	161
LSdata.....	147	PO4-3 TC.....	157	SL K 70230.....	161
LSdata.....	175	Profiline pH 3110 SET 2.....	62	SL Mn 19789.....	161
<b>M</b>		Profiline pH 3310 SET 2.....	62	SL NH4 19812.....	161
Mn-1 TP.....	155	<b>R</b>		SL Ni 19792.....	161
Mn-2 TP.....	155	RB Flex/430.....	147	SL NO2 19899.....	161
Mo-1 TP.....	155	RH 28.....	73	SL NO3 19811.....	161
Mo-2 TP.....	155	RL-G.....	93	SL Pb 19776.....	161
MPP 930-pH/FDO®/Cond-Kit.....	39	<b>S</b>		SL P04 19898.....	161
Multi 3320 SET 1.....	50	SC-FDO® 925.....	93	SL Si 70236.....	161
Multi 3510 IDS SET 4.....	46	Sensolyt® 900-P.....	31	SL SO4 19813.....	161
Multi 3620 IDS SET C.....	46	Sensolyt® ORP 900-P.....	32	SLTOC 09017.....	161
Multi 3630 IDS SET F.....	46	SenTix® 20.....	68	SL Zn 19806.....	161
Multi/ACHAT II.....	175	SenTix® 21.....	68	SO4-1 TP.....	158
<b>N</b>		SenTix® 21-3.....	68	SO4-2 TP.....	158
N2/25 Nitrate.....	155	SenTix® 22.....	68	STAPL-4/7/9.....	69
N2H4-1 TP.....	154	SenTix® 41.....	68	StirrOx® G.....	92
N5/25 Nitrite.....	156	SenTix® 41-3.....	68	<b>T</b>	
NH4-1 TP.....	151	SenTix® 42.....	68	TEP 4.....	69
NH4-2 TC (LR).....	151	SenTix® 51.....	68	TEP 7.....	69
NH4-3 TC (HR).....	151	SenTix® 52.....	68	TEP 10 Trace.....	69
NH 500/2.....	82	SenTix® 60.....	68	TetraCon® 325.....	106
NO2-1 TP.....	156	SenTix® 61.....	68	TetraCon® 325-3.....	106
NO2-2 TC.....	156	SenTix® 62.....	68	TetraCon® 325-6.....	106
NO3-1 TC.....	156	SenTix® 81.....	68	TetraCon® 325-10.....	106
NO 800.....	83	SenTix® 82.....	68	TetraCon® 325-15.....	106
N <sub>tot</sub> 1 TC (LR).....	158	SenTix® 91.....	68	TetraCon® 325-20.....	106
N <sub>tot</sub> 2 TC (HR).....	158	SenTix® 940.....	30	TetraCon® 325/C.....	107
NT USB Universal.....	27	SenTix® 940-3.....	30	TetraCon® 325/S.....	107
<b>O</b>		SenTix® 940-P.....	30	TetraCon® 925.....	35
Oxi 3205 Set 1.....	90	SenTix® 945.....	30	TetraCon® 925-3.....	35
Oxi 3310 Set 1.....	90	SenTix® 945-P.....	30	TetraCon® 925/C.....	35
OxiTop® Box.....	127	SenTix® 950.....	30	TetraCon® 925/ILV.....	35
OxiTop®-C.....	119	SenTix® 950-P.....	30	TetraCon® 925/ILV-P.....	35
OxiTop®-C/B.....	119	SenTix® 980.....	30	TetraCon® 925-P.....	35
OxiTop® Control A 6.....	123	SenTix® 980-P.....	30	TetraCon® DU/T bzw. DU/TH.....	107
OxiTop® Control AN 6.....	124	SenTix® Ag*.....	73	TPL 4.....	69
OxiTop® Control AN 12.....	124	SenTix® Au.....	73	TPL 7.....	69
OxiTop® Control B 6M.....	121	SenTix® H.....	68	TPL 10 Trace.....	69
OxiTop® Control B 6M-2.5.....	121	SenTix® HW.....	68	TS 606/2-i.....	129
OxiTop® Control S 6.....	123	SenTix® HWD.....	68	TS 606/4-i.....	129
OxiTop® IS 6.....	117	SenTix® HWT 900.....	31	TS 606-G/2-i.....	129
OxiTop® IS 12.....	117	SenTix® HWT 900-P.....	31	TS 606-G/4-i.....	129
OxiTop® OC 110.....	119	SenTix® Mic.....	68	TS 1006-i.....	129
<b>P</b>		SenTix® Mic-B.....	68	Turb® 355 IR.....	171
P6/25 Phosphate.....	156	SenTix® Mic-D.....	68	Turb® 355 T.....	171
P7/25 Phosphate.....	157	SenTix® Micro 900.....	31	Turb® 430 IR.....	171
pH/Cond 3320 SET 2.....	50	SenTix® Micro 900-P.....	31	Turb® 430 IR/SET.....	171
pH/ION 3310.....	80	SenTix® ORP.....	73	Turb® 430 T.....	171
PhotoCheck 14693*.....	161	SenTix® ORP-T 900.....	32	Turb® 430 T/SET.....	171
pHotoFlex® pH.....	147	SenTix® ORP-T 900-P.....	32	<b>U</b>	
pHotoFlex® pH/SET.....	147	SenTix® PtR.....	73	USP Kit 1.....	110
pHotoFlex® STD.....	147	SenTix® RJD.....	68	USP Kit 2.....	110
pHotoFlex® Turb.....	147	SenTix® Sp.....	68	<b>V</b>	
pHotoFlex® Turb/SET.....	147	SenTix® Sp-DIN.....	68	VisoTurb® 900-P.....	36
photoLab® 7100 VIS.....	140	SenTix® SP-T 900.....	31	<b>W</b>	
photoLab® 7600 UV-VIS.....	140	SenTix® SP-T 900-P.....	31	WLM Charger.....	27
photoLab® color + Data spectral.....	140	SenTix® Sur.....	68	WP3-D.....	93
photoLab® color + photoLab® Data spectral.....	175	Si-1 TP (LR).....	157	WP3-ST.....	93
photoLab® S6.....	142	Si-2 TP (HR).....	157	WP 90/3.....	93
photoLab® S6-A.....	142	SLAg 19797.....	161	<b>Z</b>	
photoLab® S12.....	142	SLAI 19770.....	161	ZBK 325.....	93
photoLab® S12-A.....	142	SLB 19500.....	161	ZBK-D.....	93
photoLab® S12-A.....	142	SLCa 19778.....	161	ZBK ST.....	93
photoLab® S12-A.....	142	SLCd 19777.....	161	<b>Index</b>	
photoLab® S12-A.....	142	SLCl 19897.....	161		
photoLab® S12-A.....	142	SLCr 19779.....	161		
photoLab® S12-A.....	142	SLCrO3 19780.....	161		

# Xylem | 'zīləm|

- 1) The tissue in plants that brings water upward from the roots;
- 2) a leading global water technology company.

We're a global team unified in a common purpose: creating advanced technology solutions to the world's water challenges. Developing new technologies that will improve the way water is used, conserved, and re-used in the future is central to our work. Our products and services move, treat, analyze, monitor and return water to the environment, in public utility, industrial, residential and commercial building services settings. Xylem also provides a leading portfolio of smart metering, network technologies and advanced analytics solutions for water, electric and gas utilities. In more than 150 countries, we have strong, long-standing relationships with customers who know us for our powerful combination of leading product brands and applications expertise with a strong focus on developing comprehensive, sustainable solutions.

For more information on how Xylem can help you, go to [www.xylem.com](http://www.xylem.com)

## Regional Sales Offices

### UK:

Xylem Analytics UK Limited  
Phone: +44 1462 673581  
salesuk@xylem.com  
www.xylemanalytics.co.uk

### Asia:

Xylem Analytics Japan  
Phone: +81 (0)44-222-0009  
ysijapan.support@xylem.com  
www.xylem-analytics.jp

### North America:

OI Analytical  
Phone: +1 979 690-1711  
OI-Mail@xylem.com  
www.oico.com

### Australia:

Xylem Analytics Australia  
Phone: +61 1300 995362  
salesAus@xylem.com  
www.xylem-analytics.com.au

### China:

Xylem Analytics (Beijing) Co., Ltd  
Phone: +86 10 5785 2266  
Xylemanalytics.China@xylem.com  
www.xylemanalytics.cn

Visit [www.WTW.com](http://www.WTW.com) for a listing of our global distribution partners

### France:

Xylem France  
Phone: +33 1 46 95 33 33  
analytics.commercial-fr@xylem.com  
www.xylemanalytics.com

### Middle East & Africa:

Xylem Analytics Middle East & Africa  
Phone: +971 4 806 1000  
Info.MEA@Xylem.com  
www.xylemanalytics.com

Connect with us:



/wtw.wm



/wtwgbhinternational

[wtw.com/en/newsletter](http://wtw.com/en/newsletter)



a xylem brand

## Xylem Analytics Germany Sales GmbH & Co. KG, WTW

Dr.-Karl-Slevogt-Straße 1  
D-82362 Weilheim  
Germany

Phone: +49 881 183-0  
Fax: +49 881 183-420  
Info.WTW@Xylem.com  
[www.WTW.com](http://www.WTW.com)

All names are registered tradenames or trademarks of Xylem Inc. or one of its subsidiaries. Technical changes reserved.  
© 2018 Xylem Analytics Germany Sales GmbH & Co. KG. 999199US

August 2018

# General Technical Data Electrochemistry

НеваРектив

	Digital			Analogue		
	Benchtop meters					
	inoLab® Multi IDS			inoLab®		
	Multi 9630	Multi 9620	Multi 9310	7320	7310	7110
<b>Self test</b> upon switching on	●	●	●	●	●	●
<b>Splash Proof Housing</b>	●	●	●	●	●	●
<b>Display</b>	Color graphic backlit	Color graphic backlit	Graphic backlit	Graphic backlit	Graphic backlit	LCD
<b>Simultaneous Temperature Display</b>	●	●	●	●	●	●
<b>Temperature Compensation</b>	●	●	●	●	●	●
<b>TFK 325 attachable (pH)</b>	-	-	-	●	●	●
<b>Membrane Keyboard</b> with Defined Pressure Point	●	●	●	●	●	●
<b>User Selectable Languages</b>	●	●	●	●	●	-
<b>Memory: Data Sets</b>	10000	10000	4500	5000	5000	-
<b>Real Time Clock</b>	●	●	●	●	●	-
<b>GLP Supporting Functions</b>	●	●	●	●	●	-
<b>Identification No.</b>	●	●	●	●	●	-
<b>Sensor Serial Number, Manually</b>	-	-	-	●	●	-
<b>Digital Sensor Recognition</b>	●	●	●	-	-	-
<b>Calibration Record</b>	●	●	●	●	●	-
<b>Calibration Interval Selectable</b> 1 ... 999 days	●	●	●	●	●	●
<b>User Administration</b> (via MultiLab® User)	●	●	●	-	-	-
<b>USB-Interface/ Mini-USB/A</b>	● / ●	● / ●	● / -	● / -	● / -	- / -
<b>PC Connection</b>	●	●	●	●	●	-
<b>Software MultiLab® Importer</b>	●	●	●	●	●	-
<b>Software Update</b> via Internet	●	●	●	●	●	-
<b>Firmware Update</b> via Internet	●	●	●	●	●	-
<b>Built-in Printer</b> Option	-	-	●	●	●	-
<b>Wireless ready</b>	●	●	●	-	-	-
<b>Sensor Validation</b>	●, QSC	●, QSC	●, QSC	●	●	●
<b>Dimensions without printer</b> (H x W x D)	mm (in.)	240x280 x70 (9.45 x11.02 x3.15)	240x280 x70 (9.45 x11.02 x3.15)	190x240 x80 (7.48 x9.45 x3.15)	190x240 x80 (7.48 x11.42 x3.15)	-
<b>Dimensions with printer</b> (H x W x D)	mm (in.)	-	-	190 x290 x80 (7.48 x11.42 x3.15)	190 x290 x80 (7.48 x11.42 x3.15)	-
<b>Weight without printer</b>	kg (lb.)	2.5 (5.51)	2.5 (5.51)	0.8 (1.76)	0.8 (1.76)	-
<b>Weight with printer</b>	kg (lb.)	-	-	1.0 (2.20)	1.0 (2.20)	-
<b>Universal Power Supply</b>	●	●	●	●	●	●
<b>Battery Operated</b> (not with built-in printer)	-	-	●	●	●	●
<b>Certificates</b>	CE	CE	CE	CE	CE	CE
<b>SET Available</b>	●	●	●	●	●	●
<b>Warranty</b>	3 years	3 years	3 years	3 years	3 years	3 years

	Digital			Analogue			
	Portable meters						
	MultiLine IDS			ProfileLine			
	Multi 3630	Multi 3620	Multi 3510	Multi 3320	pH/Cond 3320	3310	3110
<b>Self test</b> upon switching on	●	●	●	●	●	●	●
<b>Waterproof Housing</b>	IP 67	IP 67	IP 67	IP 67	IP 67	IP 67	IP 67
<b>Display</b>	Color Graphic	Color Graphic	Color Graphic backlit	Color Graphic backlit	Color Graphic backlit	Color Graphic backlit	LCD
<b>Simultaneous Temperature Display</b>	●	●	●	●	●	●	●
<b>Temperature Compensation</b>	●	●	●	●	●	●	●
<b>TFK 325 attachable (pH)</b>	-	-	-	-	-	●	●
<b>Keypad/Acoustic prompts</b>	●	●	●	●	●	●	●
<b>User Selectable Languages</b>	●	●	●	●	●	●	-
<b>Memory: Data Sets</b>	10000	10000	4500	5000	5000	5000	-
<b>Real Time Clock</b>	●	●	●	●	●	●	-
<b>GLP Supporting Functions</b>	●	●	●	●	●	●	-
<b>Identification No.</b>	●	●	●	●	●	●	-
<b>Calibration Record</b>	10	10	10	●	●	10	-
<b>Calibration Interval Selectable</b> 1 ... 999 days	●	●	●	●	●	●	●
<b>User Administration</b> (via MultiLab® User)	●	●	●	-	-	-	-
<b>USB Interface/ Mini-USB/A</b>	● / ●	● / ●	● / -	● / -	● / -	● / -	- / -
<b>PC Connection</b>	●	●	●	●	●	●	-
<b>Software MultiLab® Importer</b>	●	●	●	●	●	●	-
<b>Firmware Update</b> via Internet	●	●	●	●	●	●	-
<b>Wireless ready</b>	●	●	●	-	-	-	-
<b>Sensor Validation</b>	●, QSC	●, QSC	●, QSC	●	●	●	●
<b>Dimensions</b> (H x W x D)	mm (in.)	180x80 x55 (7.09 x3.15 x2.17)	180x80 x55 (7.09 x3.15 x2.17)	180x80 x55 (7.09 x3.15 x2.17)	180x80 x55 (7.09 x3.15 x2.17)	180x80 x55 (7.09 x3.15 x2.17)	180x80 x55 (7.09 x3.15 x2.17)
<b>Weight</b>	kg (lb.)	0,4 (0,88)	0,4 (0,88)	0,4 (0,88)	0,4 (0,88)	0,4 (0,88)	0,4 (0,88)
<b>Universal Power Supply</b>	●	●	USB, optional	USB, optional	USB, optional	USB, optional	-
<b>Battery Operated/ Rechargeable Batteries</b>	recharg. (NiMH)	recharg. (NiMH)	● / ●	● / ●	● / ●	● / ●	● / ●
<b>Certificates</b>	CE	CE	CE	CE	CE	CE	CE
<b>SET Available</b>	●	●	●	●	●	●	●
<b>Warranty</b>	3 years	3 years	3 years	3 years	3 years	3 years	3 years

НеваРектив

# General Technical Data Optical Instruments

НеваРеактив

	Laboratory Instruments					
	photoLab® Series			Thermoreactors		
	S6	S12	7100 VIS 7600 UV-VIS	CR 2200	CR 3200	CR 4200
<b>Cuvette Size (mm)</b>	16	16, 10, 20, 50	16, 10, 20, 50	16	16	16
<b>Self Check</b>	●	●	●	●	●	●
<b>Drain</b>	●	●	●	-	-	-
<b>Display</b>	LCD	LCD	Graphic/ backlit	LCD	LCD	LCD
<b>Keypad</b>	Silicone	Silicone	Foil with prompts	Foil with prompts	Foil with prompts	Foil with prompts
<b>Language Selection</b>	●	●	●	●	●	●
<b>Memory: Dat sets</b>	500	1000	5000/ 40 MB			
<b>Methods/ User Defined Methods</b>	130/-	150/50	250/ 1000	5;-	5;8	5,8
<b>Real Time Clock</b>	●	●	●	●	●	●
<b>GLP Supporting Functions</b>	●	●	●	●	●	●
<b>AQA</b>	●	●	●	-/●/●	-/●/●	-/●/●
<b>Identification no.</b>	●	●	●			
<b>Calibration Protocol</b>	●	●	●			
<b>Calibration Interval</b>	●	●	●			
<b>Password Protection</b>	●	●	●			
<b>Interface</b>	RS 232	RS 232	2 USB 1 Ethernet	RS 232	RS 232	RS 232
<b>PC Connection</b>	●	●	●	●	●	●
<b>PC Software (optional)</b>	-	●	●	-	-	-
<b>Alarm function</b>	-	-	●	●	●	●
<b>Method Update via Internet</b>	●	●	●/USB	-	-	-
<b>Dimensions (H x W x D)</b>	mm (in.)	140x270 x260 (5.51 (5.51 x10.63 x10.24)	140x270 x260 (5.51 (5.51 x10.63 x10.24)	404x197 x314 (15.91 (15.91 x7.76 x12.36)	185x256 x315 (7.28 (7.28 x10.08 x12.40)	185x256 x315 (7.28 (7.28 x10.08 x12.40)
<b>Weight</b>	kg (lb.)	2.3 (5.07)	2.3 (5.07)	4.5 (9.92)	3 (6.61)	4 (8.82)
<b>Universal Power Supply</b>	●	●	●	Switchable	Switchable	Switchable
<b>Rechargeable Batteries</b>	optional	optional	Yes/12V			
<b>Certificates</b>	CE	CE	CE	CE	CE	CE
<b>Warranty for defects of quality</b>	2 Years	2 Years	2 Years	2 Years	2 Years	2 Years

	Portable Instruments				
	pHotoFlex® Series			Turbidity	
	pHotoFlex® STD	pHotoFlex® pH	pHotoFlex® Turb	Turb® 430 IR/T	Turb® 3551/11
<b>Cuvette Size (mm)</b>	16, 28	16, 28	16, 28	28	25
<b>Self Check</b>	●	●	●	●	●
<b>Waterproof Housing</b>	IP 67	IP 67	IP 67	IP 67	-
<b>Display</b>	Graphic/ backlit	Graphic/ backlit	Graphic/ backlit	Graphic/ backlit	LCD
<b>Temperature Display</b>	-	●	●	-	-
<b>pH/Turbidity</b>	-/-	●/-	●/●	-/●	-/●
<b>Keypad/Acoustic prompts</b>	Silicone/●	Silicone/●	Silicone/●	Silicone/●	Foil with prompts
<b>Language Selection</b>	●	●	●	●	-
<b>Memory: Data sets</b>	100	1000	1000	1000	-
<b>Real Time Clock</b>	●	●	●	●	-
<b>GLP Supporting Functions</b>	●	●	●	●	-
<b>Identification no.</b>	●	●	●	●	-
<b>Calibration Protocol</b>	-	●	●	●	-
<b>Calibration Interval</b>	-	●	●	●	-
<b>Interface</b>	RS 232	RS 232	RS 232	RS 232	-
<b>PC Connection</b>	●	●	●	●	-
<b>LabStation for lab use incl. Rech. Batt.</b>	optional	optional	optional	optional	-
<b>PC-Software (optional)</b>	●	●	●	●	-
<b>Alarm function</b>	●	●	●	●	-
<b>Clock/Timer</b>	●/●	●/●	●/●	●/-	-
<b>Method Update via Internet</b>	●	●	●	●	-
<b>Firmware Update via Internet</b>	●	●	●	●	-
<b>Dimensions (H x W x D)</b>	mm (in.)	117x86 x236 (4.61x3.39 x9.29)	117x86 x236 (4.61x3.39 x9.29)	117x86 x236 (4.61x3.39 x9.29)	117x86 x236 (4.61x3.39 x9.29)
<b>Weight</b>	kg (lb.)	0.6 (1.32)	0.6 (1.32)	0.6 (1.32)	0.6 (1.32)
<b>Battery operated</b>	●	●	●	●	●
<b>Rechargeable Batteries and Universal Power Supply</b>	-	optional	optional	optional	-
<b>Certificates</b>	CE	CE	CE	CE	CE
<b>Sets</b>	-	●	●	●	●
<b>Warranty for defects of quality</b>	2 Years	2 Years	2 Years	2 Years	2 Years

НеваРеактив